

**Export
Version**

**2002
Dimension One Spas
& @ Home Hot Tubs
Planning Guide
& Installation Manual**

DIMENSION ONE SPAS®
HOME HYDROTHERAPY

Table of Contents

PRE-PURCHASE DECISIONS.....	1
BEFORE DELIVERY	1
<i>Typical Installation Site.....</i>	<i>1</i>
SITE ACCESS.....	2
COVER.....	2
INSTALLATION	3
ELECTRICAL HOOK UP INSTRUCTIONS	3
<i>Electrical Requirements Chart for D 1 Hot Tubs</i>	<i>4</i>
<i>Electrical Requirements Chart for @ Home Hot Tubs.....</i>	<i>5</i>
INSTALLATION CHECK LIST	5
ABOUT SMART HEAT (AVAILABLE ONLY ON DIMENSION ONE HOT TUBS).....	5
MAINTENANCE	6
DRAINING YOUR HOT TUB.....	6
CLEANING YOUR FILTER.....	6
LIGHT BULB REPLACEMENT	6
CARING FOR YOUR HOT TUB COVER.....	6
HOT TUB SPECIFICATIONS.....	6
SPECIFICATIONS FOR DIMENSION ONE SPAS	6
<i>Arena.....</i>	<i>7</i>
<i>Aurora II</i>	<i>8</i>
<i>Aurora HP.....</i>	<i>9</i>
<i>Aurora XLT.....</i>	<i>10</i>
<i>Caliente.....</i>	<i>11</i>
<i>Caliente HP.....</i>	<i>12</i>
<i>Californian.....</i>	<i>13</i>
<i>Chairman.....</i>	<i>14</i>
<i>Chairman II.....</i>	<i>15</i>
<i>Diplomat.....</i>	<i>16</i>
<i>Nautilus</i>	<i>17</i>
<i>Triad</i>	<i>18</i>
<i>Triad II</i>	<i>19</i>
SPECIFICATIONS FOR @HOME HOT TUBS.....	20
<i>Companion HP.....</i>	<i>20</i>
<i>Cove.....</i>	<i>21</i>
<i>Cove HP.....</i>	<i>22</i>
<i>Dream.....</i>	<i>23</i>
<i>Dream HP.....</i>	<i>24</i>
<i>Sojourn HP.....</i>	<i>25</i>
WIRING DIAGRAMS.....	26
DIMENSION ONE SPAS	26
@ HOME HOT TUBS	27
SPA INFORMATION	29
<i>My Spa</i>	<i>29</i>
<i>Dealer Information:</i>	<i>29</i>
<i>Dimension One Spas Inc. Information.....</i>	<i>29</i>

Pre-Purchase Decisions

Before Delivery

Before attempting to install or use your hot tub, please read these instructions thoroughly, and carefully view the video owner's manual for your Dimension One hot tub!

Because your hot tub is completely self-contained, you can install it just about anywhere you wish . . . on a deck, patio or even indoors. Just be sure to position it above ground, in an area with good drainage and on a level surface that fully contacts the bottom of the hot tub.



Typical Installation Site

A concrete slab is best but not required. You may choose to install it on a wood deck or bricks. If you choose to install your hot tub on a raised deck or indoors, we suggest you contact a structural engineer to confirm the surface will hold a hot tub filled with water. Settlement of your deck or slab may result in damage to the hot tub, which is not covered by warranty. (See specifications in this booklet.) Wherever you plan to install your hot tub, be sure the surface is flat and solid. Locate your hot tub so that the equipment is above grade and not subject to flooding. Water should always drain away from the hot tub. If you are placing your hot tub next to an obstacle, such as a fence or wall, be sure that you place the hot tub with the topside primary control panel facing forward for easy equipment access. Locate the vents on the drawing of your particular Dimension One hot tub. This is where cool air will enter and warm air will escape during hot tub operation. Please ensure that these areas are always free of obstructions. Also, allow additional space around the hot tub for any accessories you may have purchased - for example an E-Z Lifter® spa cover lift, steps, or a gazebo. Check with your dealer on these additional space requirements.



Note

In most cities and counties, permits are required for the installation of electrical circuits or the construction of exterior structures such as decks and gazebos. Some communities have also adopted residential barrier codes that may require fencing and/or self-closing gates on the property to prevent unsupervised access to a hot tub by young children.



Note

If you install the spa or hot tub indoors, the surrounding area should be waterproof or water resistant. Water may be splashed out during normal usage and when entering or exiting the spa. Dimension One Spas is not responsible for any water damage to any indoor location for any reason.

Dimension One and @Home hot tubs are equipped with a locking cover that meets or exceeds the "Standard for Safety Covers," but is not an adequate safety measure to prevent unsupervised entry. Please check with your local Building Permit Office that can inform you on any special requirements needed for installation of your electrical, decking or required barriers. Your local dealer may also provide you with information on local building and electrical codes.

Site Access

Please refer to the drawings on pages 7 - 26 for the specifications and appropriate measurements for your hot tub model. You will need the measurements of your hot tub in order to determine the clearance needed for delivery. **CAUTION:** DUE TO MANUFACTURING TOLERANCES THERE COULD BE SOME MINOR DIFFERENCES BETWEEN THE ACTUAL MEASUREMENTS OF YOUR SPA AND THE DRAWING BELOW. IF SITE PLANNING IS CRITICAL TO SUCH TOLERANCES, BE SURE TO MEASURE YOUR ACTUAL SPA. Your hot tub will probably be delivered on a dolly or cart. The additional distance from the ground to the dolly or cart must also be included in your measurements for vertical clearance. Also, take into consideration that if your hot tub must be transported up-hill or taken upstairs, you may need additional clearance or assistance. Be sure to remove obstacles such as gates, planters, or items attached to the house. The point of entry must be clear of air conditioning units, heating units, meters, electrical boxes, etc. It is best that your dealer pre-inspect the installation site and determine the best way to deliver your hot tub. In rare cases, a crane must be brought in to assist in an installation. Your Dimension One dealer will supervise this for you. Here is a list of some of the most common installation hazards in planning your route:

- Gates
- Fences
- Eaves
- Gutters
- Air Conditioners
- Heaters
- Hose Bibs
- Bushes
- Overhanging Branches
- Steps
- 90° Turns

Cover

The cover supplied with your hot tub is constructed of the highest quality materials and is equipped with quick-release keyed buckle locks that meet standards set by American Standards for Testing and Measurement (ASTM). When the hot tub is not in use, it is recommended that the cover locks always be utilized to discourage unsupervised use and to minimize heat loss. When installing the cover on your hot tub, be sure it is facing the correct direction. When standing in front of the topside primary control panel, the center seam or hinge should run horizontally. You should be able to lift the handle of the cover and see the hot tub control panel. Allow 18 inches of extra space on the backside of the hot tub where the optional E-Z Lifter® will rest in its upright, open position.



Installation

Electrical Hook Up Instructions



Warning

Do not turn on electrical power to your hot tub until told to do so later in this manual.

Have a licensed electrician run the required 240-volt power line to the hot tub installation site. The power inlet connection is located in the pedestal on the left side of the hot tub, approximately 25" from the front. This connection is designed to mate with a Carlon 1" conduit body Type LB, Access Fitting E986F or any 1" female PVC conduit fitting. The manufacturer's label lists the power requirements for your hot tub. **We recommend that only a licensed and bonded electrician do the initial hot tub hook-up.**



Note

This unit requires a GFCI (Ground Fault Circuit Interrupter). We have provided an enclosed instructional flyer for a licensed electrician. A "line of sight" service disconnect must be located where visible from the hot tub, not less than 5 feet from the hot tub and not to exceed 50 feet from the hot tub. This requirement may be filled with the GFCI sub-panel. **All supply wire to be rated minimum 90°C.**

To hook-up your hot tub, follow these instructions:

1. Remove the screws holding the equipment access panel to the front of the hot tub cabinet and set the panel aside.
2. Loosen the four screws located on the front of the black equipment control can and remove the door from the control can to allow access to the four wire connection terminal block.
3. Attach 1" rigid non-metallic conduit to the conduit nipple located in the pedestal base on the side of the hot tub and run required conductors through the conduit to the equipment can.
4. Connect the four wires to the equipment system terminal block (TB1) as indicated on the wiring diagram in the back of this manual.
5. Configure jumpers 1 and 2 on the upper right corner of the PC Board to match the circuit size being used for the hot tub (see Electrical Requirements Chart on the following page for proper wire size). See the chart below for the correct settings.

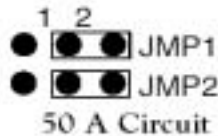
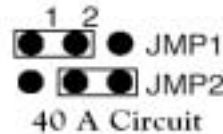
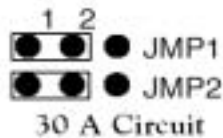

Electrical Requirements Chart for D 1 Hot Tubs

Model	Power	Branch Circuit	Circuit Protection	Wire Gauge
Arena	240V, 30A	3 wire + ground	40A	#6 AWG
	240V, 24A	3 wire + ground	30A	#8 AWG
Aurora II	240V, 38A	3 wire + ground	50A	#6 AWG
	240V, 32A	3 wire + ground	40A	#6 AWG
	240V, 24A	3 wire + ground	30A	#8 AWG
Aurora HP	240V, 38A	3 wire + ground	50A	#6 AWG
	240V, 30A	3 wire + ground	40A	#6 AWG
	240V, 24A	3 wire + ground	30A	#8 AWG
Aurora XLT	240V, 38A	3 wire + ground	50A	#6 AWG
	240V, 32A	3 wire + ground	40A	#6 AWG
	240V, 24A	3 wire + ground	30A	#8 AWG
Caliente	240V, 40A	3 wire + ground	40A	#6 AWG
	240V, 30A	3 wire + ground	30A	#8 AWG
Caliente HP	240V, 50A	3 wire + ground	50A	#6 AWG
	240V, 40A	3 wire + ground	40A	#6 AWG
	240V, 30A	3 wire + ground	30A	#8 AWG
Californian	240V, 38A	3 wire + ground	50A	#6 AWG
	240V, 32A	3 wire + ground	40A	#6 AWG
	240V, 24A	3 wire + ground	30A	#8 AWG
Chairman	240V, 38A	3 wire + ground	50A	#6 AWG
	240V, 32A	3 wire + ground	40A	#6 AWG
	240V, 24A	3 wire + ground	30A	#8 AWG
Chairman II	240V, 38A	3 wire + ground	50A	#6 AWG
	240V, 32A	3 wire + ground	40A	#6 AWG
	240V, 24A	3 wire + ground	30A	#8 AWG
Diplomat	240V, 38A	3 wire + ground	50A	#6 AWG
	240V, 32A	3 wire + ground	40A	#6 AWG
	240V, 24A	3 wire + ground	30A	#8 AWG
Nautilus	240V, 38A	3 wire + ground	50A	#6 AWG
	240V, 32A	3 wire + ground	40A	#6 AWG
	240V, 24A	3 wire + ground	30A	#8 AWG
Triad	240V, 30A	3 wire + ground	40A	#6 AWG
	240V, 24A	3 wire + ground	30A	#8 AWG
Triad II	240V, 30A	3 wire + ground	40A	#6 AWG
	240V, 24A	3 wire + ground	30A	#8 AWG

Electrical Requirements Chart for @ Home Hot Tubs

Model	Power	Branch Circuit	Circuit Protection	Wire Gauge
Companion HP	240V, 24A	3 wire + ground	30A	#8 AWG
Cove	240V, 29A	3 wire + ground	40A	#6 AWG
	240V, 24A	3 wire + ground	30A	#8 AWG
	120V, 12A	3 wire + ground*	15A	#12AWG
Cove HP	240V, 32A	3 wire + ground	40A	#6 AWG
	240V, 24A	3 wire + ground	30A	#8 AWG
Dream	240V, 24A	3 wire + ground	30A	#8 AWG
Dream HP	240V, 32A	3 wire + ground	40A	#6 AWG
	240V, 24A	3 wire + ground	30A	#8 AWG
Sojourn HP	240V, 32A	3 wire + ground	40A	#6 AWG
	240V, 24A	3 wire + ground	30A	#8 AWG

*A GFCI protected cord is required (P/N 1560-09)

The power inlet connection is located in the pedestal on the left side of the hot tub, approximately 25" from the front. The front of the hot tub is the section that includes the topside, primary control panel.

Installation Check List

- | | |
|---------------------------------------------------------------------------------------------------------------------------------------------------------------------------------------------------------------------------------------------------------------------------------------------------------------------------------------------------------------------------------------------------------------------------------------------------------------------------------------------------------------------------------------------------------------------------------------------------------------------------------------------------------------------------------------------------------------------------------------------------------------|-----------------------------------------------------------------------------------------------------------------------------------------------------------------------------------------------------------------------------------------------------------------------------------------------------------------------------------------------------------------------------------------------------------------------------------------------------------------------------------------------------------------------------------------------------------------------------------------------|
| <ul style="list-style-type: none"> <input type="checkbox"/> Owner's Manual <input type="checkbox"/> Hot Tub Cover <input type="checkbox"/> Locks on Hot Tub and Cover <input type="checkbox"/> Cabinet Care <input type="checkbox"/> Filter Use, Removal and Cleaning <input type="checkbox"/> GFCI Location <input type="checkbox"/> Electrical Disconnect Location <input type="checkbox"/> How to Fill and Drain Hot tub <input type="checkbox"/> How to Use the Topside Primary Control <input type="checkbox"/> Instructions for your Ultra Pure Water Management System, CrystalZone®, or CD ClearZone™ Ozone Generators & Water Management Systems | <ul style="list-style-type: none"> <input type="checkbox"/> Drain Valve and Hose Bib <input type="checkbox"/> Changing Light Lens Cap <input type="checkbox"/> Selector Valve Control <input type="checkbox"/> Adjusting/Interchanging Jets <input type="checkbox"/> Adjusting the NeckFlex™ Jet Pillow and Interchangeable Jets <input type="checkbox"/> Water Care Guide <input type="checkbox"/> Automatic Bromine Feeder (Optional) <input type="checkbox"/> The Use of the Optional PureVision™ Cartridges |
|---------------------------------------------------------------------------------------------------------------------------------------------------------------------------------------------------------------------------------------------------------------------------------------------------------------------------------------------------------------------------------------------------------------------------------------------------------------------------------------------------------------------------------------------------------------------------------------------------------------------------------------------------------------------------------------------------------------------------------------------------------------|-----------------------------------------------------------------------------------------------------------------------------------------------------------------------------------------------------------------------------------------------------------------------------------------------------------------------------------------------------------------------------------------------------------------------------------------------------------------------------------------------------------------------------------------------------------------------------------------------|

Please check these items before you fill your hot tub with water:

About Smart Heat (Available Only on Dimension One Hot Tubs)

Smart Heat provides maximum heat recovery using the amperage that you have available. Through computerized load sharing, the system automatically recognizes the temperature differential and the number of jet pumps in use, compares it with the available power and adjusts the heater to maximize heater output.

Maintenance

Draining Your Hot Tub

Locate the hose bib at the bottom of the hot tub, on the pedestal, to the left of the equipment compartment on Dimension One hot tubs, and to the right on @Home hot tubs. This is where you can hook-up your hose for hot tub draining.

Cleaning Your Filter

Your hot tub is equipped with one or two top access filter cartridges. For optimum performance and water quality, we recommend that you clean the filters every month. Before you fill your hot tub, practice removing and reinstalling a filter cartridge.



Note

The EZ Lock Filter does *not* require excessive force to remove or install. “Finger-tip” pressure is all that is needed.

Light Bulb Replacement

Notice the location of the light. To change the bulb, drain hot tub below the level of the light and unscrew the light cover using the special tool provided in the owner’s manual packet.



Note

Never try to remove the light housing cover without the special tool.

Caring For Your Hot Tub Cover

The thermal cover for your hot tub is an extremely durable foam insulated product. See the manufacturer’s literature for proper cleaning instructions. When the hot tub is not in use, it is recommended that the cover locks always be utilized to discourage unsupervised use and to minimize heat loss.

Hot Tub Specifications

The following section of this manual gives you detailed information on the sizes of both Dimension One and @Home hot tubs. Dimension One hot tubs are listed first, alphabetically by model, followed by @Home hot tubs in the same order.

Specifications for Dimension One Spas

These specifications include:

- spa shape,
- dimensions,
- electrical requirements,
- water capacity,
- type and number of Hydrotherapy Jets,
- weight,
- type of Water Management System,
- number and type of pumps,
- type of skirt,
- type and number of controls

Arena



DUE TO MANUFACTURING TOLERANCES THERE COULD BE SOME MINOR DIFFERENCES BETWEEN THE ACTUAL MEASUREMENTS OF YOUR SPA AND THE DRAWING BELOW. IF SITE PLANNING IS CRITICAL TO SUCH TOLERANCES, BE SURE TO MEASURE YOUR ACTUAL SPA.

2002 Arena Export

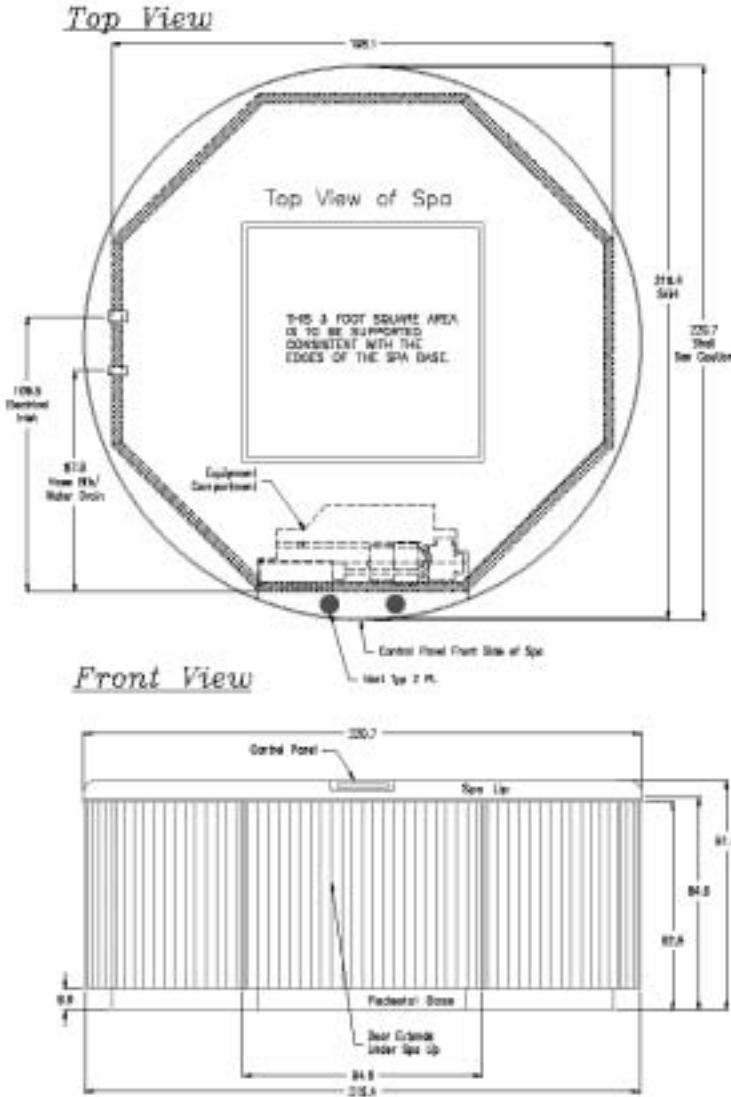

Spa Specifications	
Shape	Round
Shell Material	Ultralite/Clanitec
Depth	221
Width	321
Height	61
Corner Radii	N/A
Water Capacity	1287
Capacity	7+
Dry Weight	231
Full Weight	1613
Pump Brand	Aqua-Rite
Motor Size	2.0 Hp
# Pumps/Speed	One/Single
Light	1
Control System	MSPA-1-CE
Upper Control	Mid Range Control
Auxiliary Upper Control	No
Programmable	Yes
Heater	99-02PaxFlo 2.1 kW
Voltage	240
Amperage	16/2X15/32
GFCl Cord	No
Thermostat	Electronic
Skirt	Wood or Synthetic
Poly Floor	Yes
Gate Valves	2
Valve	1
Plumb Systems	2
Drains	2+ Floor
Skimmer	8" W/er
VCR Jet-Air Adjustable	2
VCR Jet - Rotator	8
Mini Directional in NFJ	0
VCR Mini Directional	2
VCR Mini Rotator	2
Ozone	2
Typhoon Jet	2
Total Jets	16
Filter	1 X 75
Ultra Pure System	CZAMS Standard
Fluores	0
NeckFlex Jet	0
Dynamic Massage Sequence w/ control panel	No

Caution

DUE TO MANUFACTURING TOLERANCES THERE COULD BE SOME MINOR DIFFERENCES BETWEEN THE ACTUAL MEASUREMENTS OF YOUR SPA AND THE DRAWING BELOW. IF SITE PLANNING IS CRITICAL TO SUCH TOLERANCES, BE SURE TO MEASURE YOUR ACTUAL SPA.

NOTES:

- Subject to change without notice.
- Engineering specs may differ slightly from brochure.
- For 1-2 (1/2" lip) installation allow 45.7 cm clearance on the back side of the spa.
- Alternative solutions may add significant weight. Ask your dealer for exact details.

Dimension One Spas	2002 D1 (Export) Spas
Doc-142	Rev 0
Doc-142	Rev 0
Doc-142	Rev 0

Aurora II



DUE TO MANUFACTURING TOLERANCES THERE COULD BE SOME MINOR DIFFERENCES BETWEEN THE ACTUAL MEASUREMENTS OF YOUR SPA AND THE DRAWING BELOW. IF SITE PLANNING IS CRITICAL TO SUCH TOLERANCES, BE SURE TO MEASURE YOUR ACTUAL SPA.

2002 Aurora HP Export

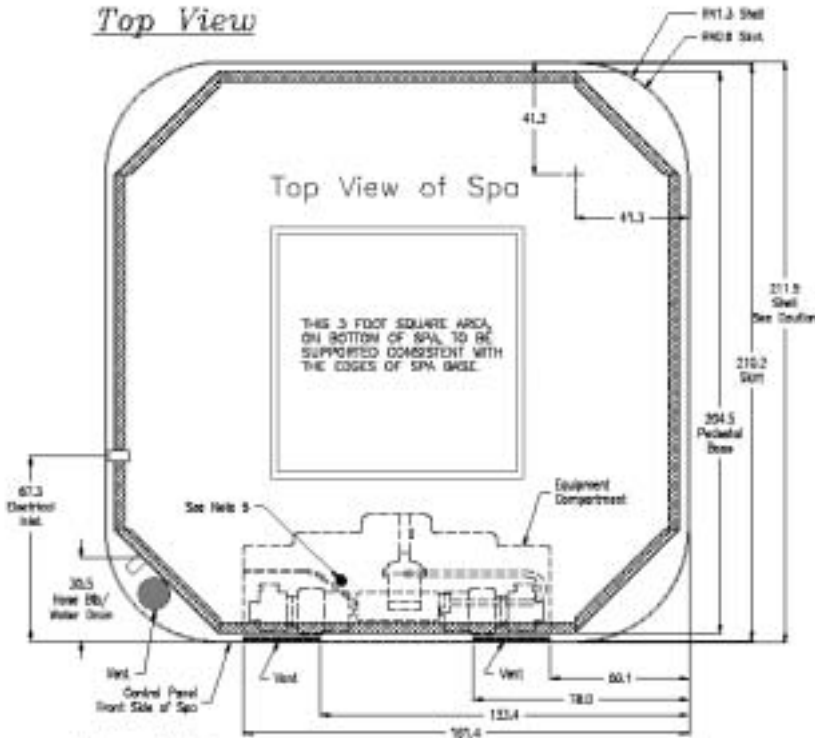

Front View

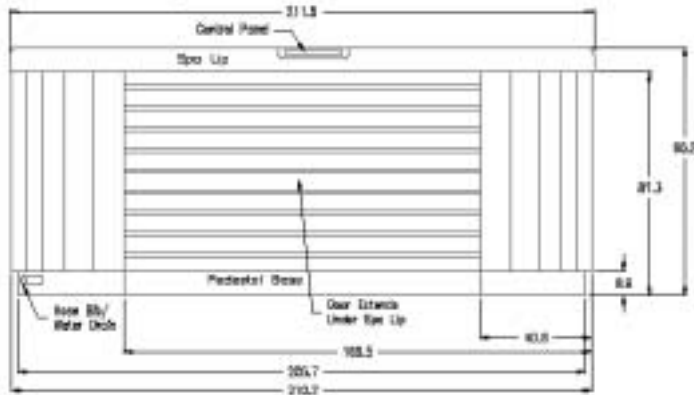

Spa Specifications	
Shape	Square
Shell Material	Ultraflex/Granite
Depth	214
Width	214
Height	91
Corner Radii	41
Gallage	1138
Capacity	5+
Dry Weight	283
Full Weight	1413
Pump Brand	Aqua-80
Motor Size	2.0 Hp
# Pumps/Speed	Two/Single
Light	1
Control System	MSPA-MP-CE
Upper Control	Mid Range Control
Auxiliary Upper Control	No
Programmable	Yes
Heater	99-02 FastFlo
Voltage	4.0 kW
	240
Amperage	16(2x8/32)
GFCI Cord	No
Thermostat	Electronic
Skirt	Wood / Synthetic
Poly Floor	Yes
Gate Valves	4
Valve	0
Plumb Systems	2
Drains	4+Floor
Skimmer	8" Weir
VCR Jet-Air Adjustable	2
Non-Adjustable Euro Jet	2
VCR Jet - Rotator	6
Mini Directional in NFJ	0
VCR Mini Directional	11
VCR Mini Rotator	2
Ozone	2
Typhoon Jet	1
Total Jets	28
Filter	1 x TS
Ultra Pure System	CZWMS-Optional
Pillows	3
NeckFlex Jet	0
Dynamic Massage Sequencer w/ control panel	No

Caution:

Due to manufacturing tolerances there could be some minor differences between the actual measurements of your spa and the drawings above. If site planning is critical to such tolerances, be sure to measure your actual spa.

Note:

1. Subject to change without notice
2. Engineering specs may differ slightly from brochure.
3. For E-Z Lift after installation allow 18" clearance on the back side of the spa.
4. Alternative cabinets may add significant weight. Ask your dealer for exact details.
5. This is the recommended location for drilling a hole for bringing the power lines in through the bottom of the spa. Be careful not to puncture a plumbing line inside the Equipment Compartment (drill from the inside Compartment out)

Revised By J. Casella Date: 7/17/02 Part Number ECR-2117	Dimension One Spa 2002 D1 (Export) Base Part No: Doc-142 Rev: 1
------------------------------------------------------------------------------------	--------------------------------------------------------------------------------------------------------------

Aurora HP



DUE TO MANUFACTURING TOLERANCES THERE COULD BE SOME MINOR DIFFERENCES BETWEEN THE ACTUAL MEASUREMENTS OF YOUR SPA AND THE DRAWING BELOW. IF SITE PLANNING IS CRITICAL TO SUCH TOLERANCES, BE SURE TO MEASURE YOUR ACTUAL SPA.

2002 Aurora HP Export

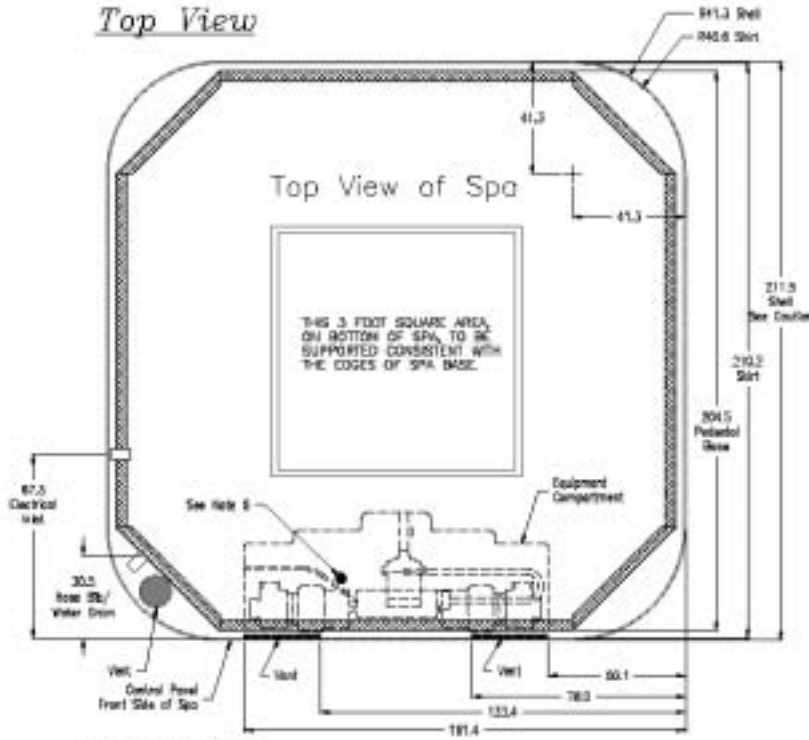

Front View

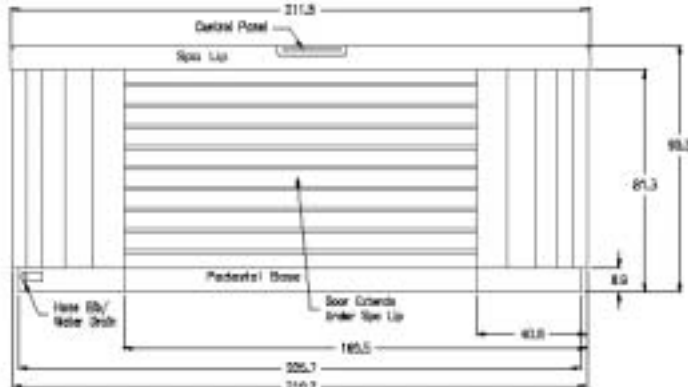

Spa Specifications	
Shape	Square
Shell Material	UltraRite/Granite
Depth	214
Width	214
Height	81
Corner Radii	41
Gallons	1136
Capacity	5+
Dry Weight	283
Full Weight	1413
Pump Brand	Aqua-Ro
Motor Size	2.8 Hp
# Pumps/Speed	Two/Single
Light	1
Control System	MSPA-MP-CE
Upper Control	Mid Range Control
Auxiliary Upper Control	No
Programmable	Yes
Heater	99-02 FastFlo
Voltage	4.8 kW
Ampage	240
GFCI Card	No
Thermostat	Electronic
Skirt	Wood / Synthetic
Poly Floor	Yes
Gate Valves	4
Valve	0
Plumb Systems	2
Drains	4/Floor
Skimmer	8" Weir
VCR Jet-Air Adjustable	2
Non-Adjustable Euro Jet	2
VCR Jet - Rotator	6
Mini Directional in NPJ	0
VCR Mini Directional	11
VCR Mini Rotator	2
Ozone	2
Typhoon Jet	1
Total Jets	28
Filter	1 x 75
Ultra Pure System	C2WMS-Optional
Pillows	3
Neck Flex Jet	0
Dynamic Massage Sequencer w/ control panel	No

Caution:

Due to manufacturing tolerances there could be some minor differences between the actual measurements of your spa and the drawings above. If site planning is critical to such tolerances, be sure to measure your actual spa.

Note:

1. Subject to change without notice.
2. Engineering specs may differ slightly from brochure.
3. For E-Z Lifter installation allow 18" clearance on the back side of the spa.
4. Alternative cabinets may add significant weight. Ask your dealer for exact details.
5. This is the recommended location for drilling a hole for bringing the power lines in through the bottom of the spa. Be careful not to puncture a plumbing line inside the Equipment Compartment (drill from the inside Compartment out).

Order Number Order Description P.O. Number Date	Order By J. Gaudin Rep. Number S. Hutchins 3/17/02 Order # ECR-2117	Dimension One Spas 2002 D1 (Export) Spec. Doc-142 Rev. 8 7/1/02 1 of 1
----------------------------------------------------------	---------------------------------------------------------------------------------------	---------------------------------------------------------------------------------------

Aurora XLT



DUE TO MANUFACTURING TOLERANCES THERE COULD BE SOME MINOR DIFFERENCES BETWEEN THE ACTUAL MEASUREMENTS OF YOUR SPA AND THE DRAWING BELOW. IF SITE PLANNING IS CRITICAL TO SUCH TOLERANCES, BE SURE TO MEASURE YOUR ACTUAL SPA.

2002 Aurora XLT Export

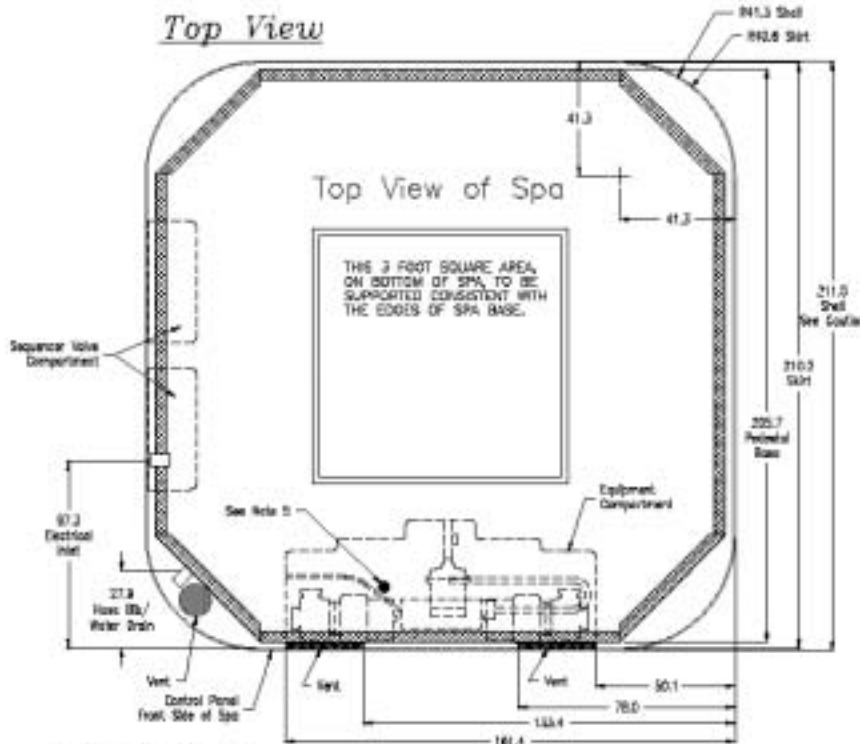

Spa Specifications	
Shape	Square
Shell Material	Ultraflex
Depth	214
Width	214
Height	91
Corner Radii	41
Liters	1138
Capacity	5+
Dry Weight (kg)	285
Full Weight (kg)	1413
Pump Brand	Aqua Flow
Motor Size	2.0 Hp
# Pumps/Speed	Two/Single
Light	1
Control System	MSPA-MP-CE
	Scrolling Message Center
Upper Control	Yes
Auxiliary Upper Control	Yes
Programmable	Yes
Heater	55-82 FastFlo
Voltage	4.0 kW
	240
Amperage	16/24/16/32
GFCI Cord	No
Thermostat	Electronic
Skirt	Wood/Synthetic
Poly Floor	Yes
Gate Valves	4
Valve	0
Plumb Systems	1
Drains	4+ Floor
Skimmer	8\"/>

Front View

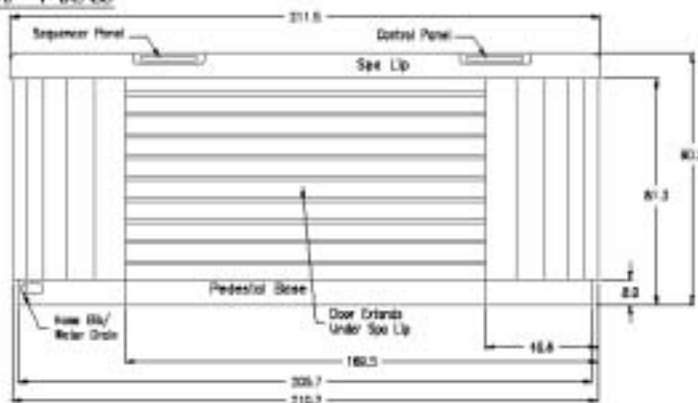

Caution:

Due to manufacturing tolerances there could be some minor differences between the actual measurements of your spa and the drawings above. If site planning is critical to such tolerances, be sure to measure your actual spa.

Note:

1. Subject to change without notice.
2. Engineering specs may differ slightly from brochure.
3. For E-2 Lifter installation allow 18" clearance on the back side of the spa.
4. Alternative cabinets may add significant weight. Ask your dealer for exact details.
5. This is the recommended location for drilling a hole for bringing the power lines in through the bottom of the spa. Be careful not to puncture a plumbing line inside the Equipment Compartment (drill from the inside Compartment out.)

Sales Order: Dealer Order: Date:	Order No: J. Ouedjro Date: 7/17/02 Sales Rep: S. Hutchings Date: 7/17/02 Order: PCR-2117	Dimension One Spa 2002 D1 (Export) Spec. Doc-142 None 8 1 of 1
----------------------------------------	---------------------------------------------------------------------------------------------------------------	------------------------------------------------------------------------------------

Caliente



DUE TO MANUFACTURING TOLERANCES THERE COULD BE SOME MINOR DIFFERENCES BETWEEN THE ACTUAL MEASUREMENTS OF YOUR SPA AND THE DRAWING BELOW. IF SITE PLANNING IS CRITICAL TO SUCH TOLERANCES, BE SURE TO MEASURE YOUR ACTUAL SPA.

2002 Caliente Export

Top View

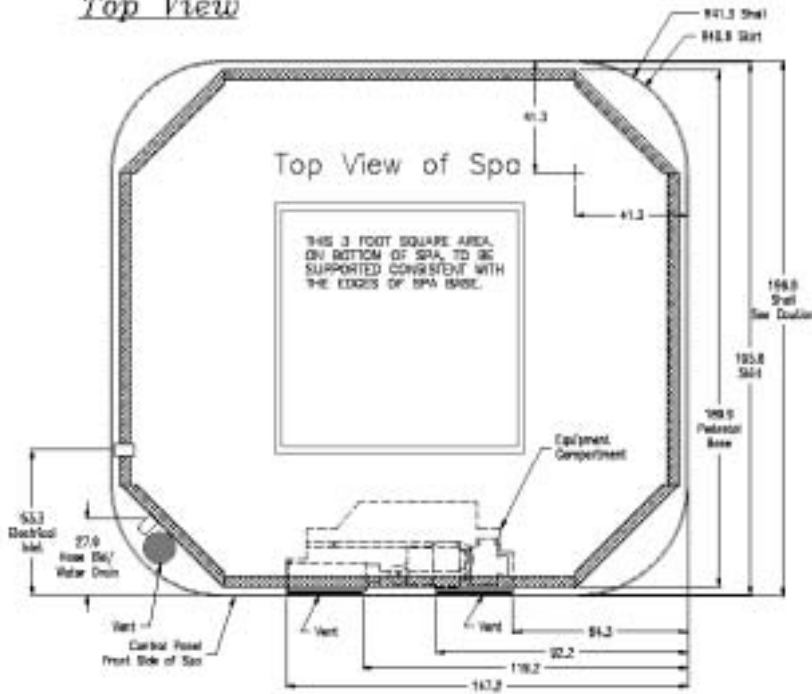

Spa Specifications

Shape	Rectangular
Shell Material	Ultralek
Depth	199
Width	213
Height	7.6
Corner Radii	41
Gallorage	1041
Capacity	5
Dry Weight	229
Full Weight	1170
Pump Brand	Aqua-fo
Motor Size	2.0 hp
# Pumps/Speed	One/Single
Light	1
Control System	MSPA-MP-CE
Upper Control	Mid Range Control
Auxiliary Upper Control	No
Programmable	Yes
Heater	99-02 FastFlo
Voltage	4.0 kW
Voltage	240
Amperage	16/2X16/32
GFCI Cont	No
Thermostat	Electronic
Skirt	Wood / Synthetic
Poly Floor	Yes
Gate Valves	2
Valve	1
Plumb Systems	2
Drains	2+Floor
Skimmer	8" Visc
VCR Jet-Air Adjustable	0
VCR Jet - Rotator	2
Mini Directional in NFJ	0
Non-Adjustable Euro Jets	21
VCR Mini Directional	18
VCR Mini Rotator	2
Ozone	2
Typhoon Jet	0
Total Jets	43
Filter	1 X 75
Ultra Pure System	CZWMS Standard
Pillows	2
NeckFlex Jet	0
Dynamic Message Sequencer w/ control panel	No

Front View

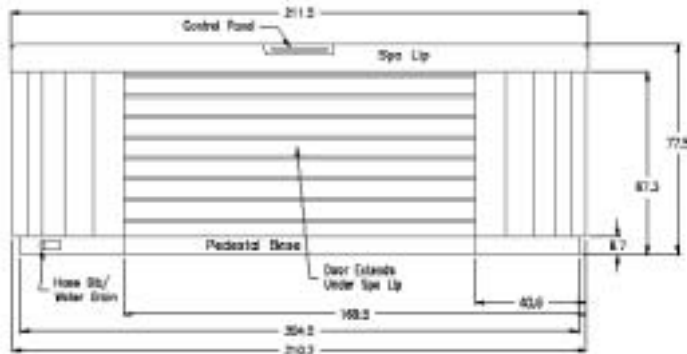

Caution:

Due to manufacturing tolerances there could be some minor differences between the actual measurements of your spa and the drawings above. If site planning is critical to such tolerances, be sure to measure your actual spa.

Note:

1. Subject to change without notice.
2. Engineering specs may differ slightly from brochure.
3. For E-Z Lifter installation allow 18" clearance on the back side of the spa.
4. Alternative cabinets may add significant weight. Ask your dealer for exact details.

Order Number Order Date Order Number Order Number Order Number	Drawn By J. Coufalo Date 8/16/02 Rev 01/16/02 EDR-2117	Dimension One Spas 2002 D1 (Export) Specs. Doc-142 Rev 0 8/17/02
----------------------------------------------------------------------------	--------------------------------------------------------------------------	------------------------------------------------------------------------------

Caliente HP



DUE TO MANUFACTURING TOLERANCES THERE COULD BE SOME MINOR DIFFERENCES BETWEEN THE ACTUAL MEASUREMENTS OF YOUR SPA AND THE DRAWING BELOW. IF SITE PLANNING IS CRITICAL TO SUCH TOLERANCES, BE SURE TO MEASURE YOUR ACTUAL SPA.

2002 Caliente HP Export

Top View

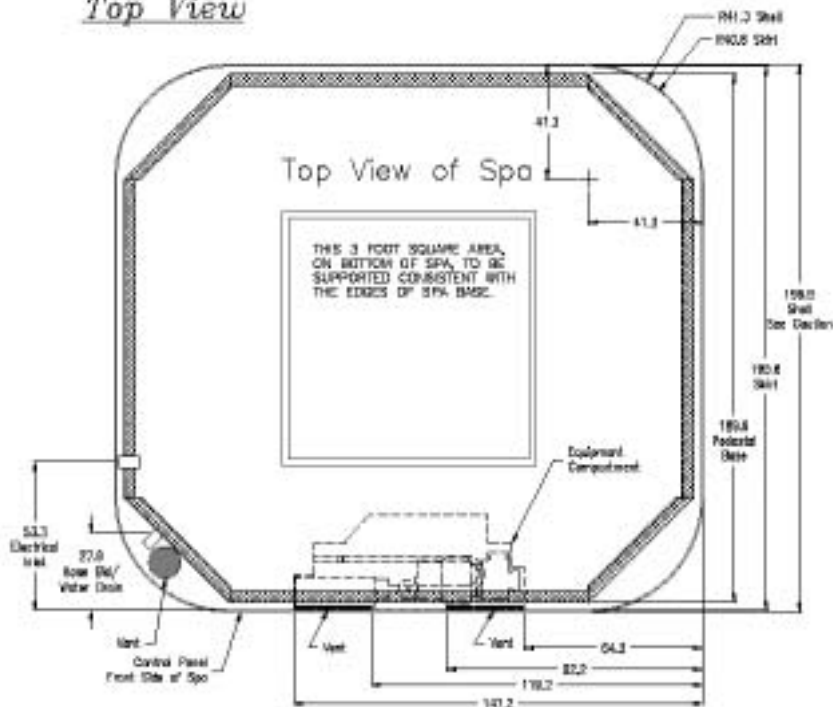

Spa Specifications

Shape	Rectangular
Shell Material	Ultraflex/Granite
Depth	197
Width	213
Height	76
Corner Radii	41
Gallons	940
Capacity	5
Dry Weight	263
Full Weight	1204
Pump Board	Aqua-40
Motor Size	2.0 Hp
# Pumps/Speed	Two/Single
Light	1
Control System	MSPA-AMP-CE
Upper Control	Scrolling Message Center
Auxiliary Upper Control	Yes
Programmable	Yes
Heater	99-02 FastFlo
Voltage	4.0 kW
Amperage	240
GFCI Cord	10/2X30/32
Thermostat	No
Skirt	Electronic
Poly Floor	Wood / Synthetic
Gate Valves	Yes
Valve	4
Plumb Systems	0
Drains	2
Skimmer	4+Floor
VCR Jet-Air Adjustable	6\" Weir
VCR Jet - Rotator	2
Mini Directional in NFJ	2
Non-Adjustable	0
Euro Jets	17
VCR Mini Directional	18
VCR Mini Rotator	2
Ozone	1
Typhoon Jet	0
Total Jets	42
Filter	2 X 75
Ultra Pure System	Yes
Pilows	2
NeckFlex Jet	0
Dynamic Message Sequencer w/ control panel	No

Front View

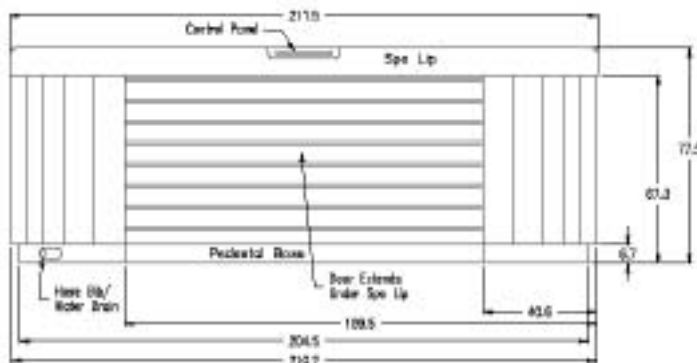

Caution:

Due to manufacturing tolerances there could be some minor differences between the actual measurements of your spa and the drawings above. If site planning is critical to such tolerances, be sure to measure your actual spa.

Note:

1. Subject to change without notice.
2. Engineering specs may differ slightly from brochure.
3. For E-2 Lifter installation allow 18" clearance on the back side of the spa.
4. Alternative cabinets may add significant weight. Ask your dealer for exact details.

Order Number: Order Date: Order Status: Order Total:	Order By: J. Chaudhry B. Kuching 771702 ECR-2117	Dimension One Spas 2002 D1 (Export) Spec. Date: 10/27/02 Page 1 of 1
---------------------------------------------------------------	--------------------------------------------------------------	----------------------------------------------------------------------------------------------

Californian



DUE TO MANUFACTURING TOLERANCES THERE COULD BE SOME MINOR DIFFERENCES BETWEEN THE ACTUAL MEASUREMENTS OF YOUR SPA AND THE DRAWING BELOW. IF SITE PLANNING IS CRITICAL TO SUCH TOLERANCES, BE SURE TO MEASURE YOUR ACTUAL SPA.

2002 Californian Export

Top View

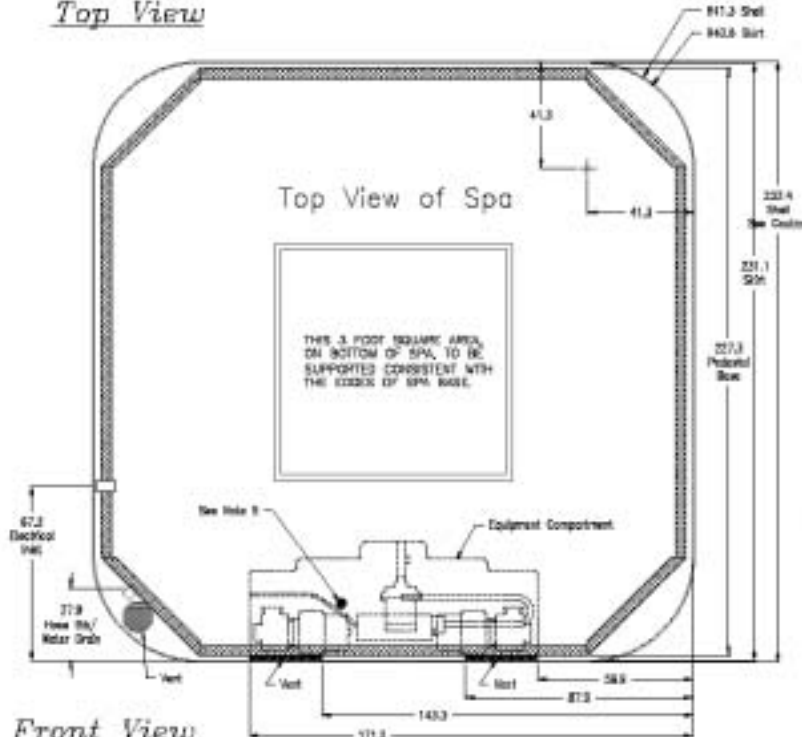

Spa Specifications	
Shape	Square
Shell Material	Ultralite/Corlon
Depth	234
Width	234
Height	91
Corner Radii	41
Cellonage	1514
Capacity	7
Dry Weight	306
Full Weight	1612
Pump Brand	Aqua-Lo
Motor Size	2.0 Hp
# Pumps/Speed	Two/Single
Light	1
Control System	MSPA-MP-CE
	Scrolling Message Center
Upper Control	
Auxiliary Upper Control	Yes
Programmable	Yes
	99-00 FastFlo
Heater	4.0 kW
Voltage	240
Amperage	15/20/15/30
GFCI Cont.	No
Thermostat	Electronic
Seat	Wood / Synthetic
Poly Floor	Yes
Cale Vises	4
Vise	1
Pump Systems	3
Doors	4-Floor
Summer	8" Water
VCR Jet-Air Adjustable	6
VCR Jet - Rotator	11
Mini Directional in NFJ	2
VCR Mini Directional	2
VCR Mini Rotator	2
Crone	1
Typhoon Jet	1
Total Jets	26
Filter	2 x 75
Ultra Pure System	Yes
Pillows	3
NeckFlex Jet	1
Dynamic Massage Sequencer w/ control panel	No

Front View

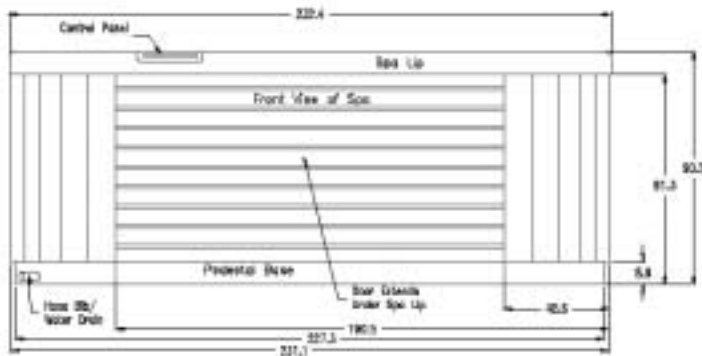

Caution:

Due to manufacturing tolerances there could be some minor differences between the actual measurements of your spa and the drawings above. If site planning is critical to such tolerances, be sure to measure your actual spa.

Note:

1. Subject to change without notice.
2. Engineering specs may differ slightly from brochure.
3. For E-2 Lifter installation allow 18" clearance on the back side of the spa.
4. Alternative cabinets may add significant weight. Ask your dealer for exact details.
5. This is the recommended location for drilling a hole for bringing the power line in through the bottom of the spa. Be careful not to puncture a plumbing line inside the Equipment Compartment (drill from the inside Compartment out)

J. Gaudin Sales Manager TYRIS 1-800-217-142	Dimension One Spas 2002 D1 (Export) Spec. Doc-142 7/1/02
None	3 of 1

Chairman



DUE TO MANUFACTURING TOLERANCES THERE COULD BE SOME MINOR DIFFERENCES BETWEEN THE ACTUAL MEASUREMENTS OF YOUR SPA AND THE DRAWING BELOW. IF SITE PLANNING IS CRITICAL TO SUCH TOLERANCES, BE SURE TO MEASURE YOUR ACTUAL SPA.

2002 Chairman Export

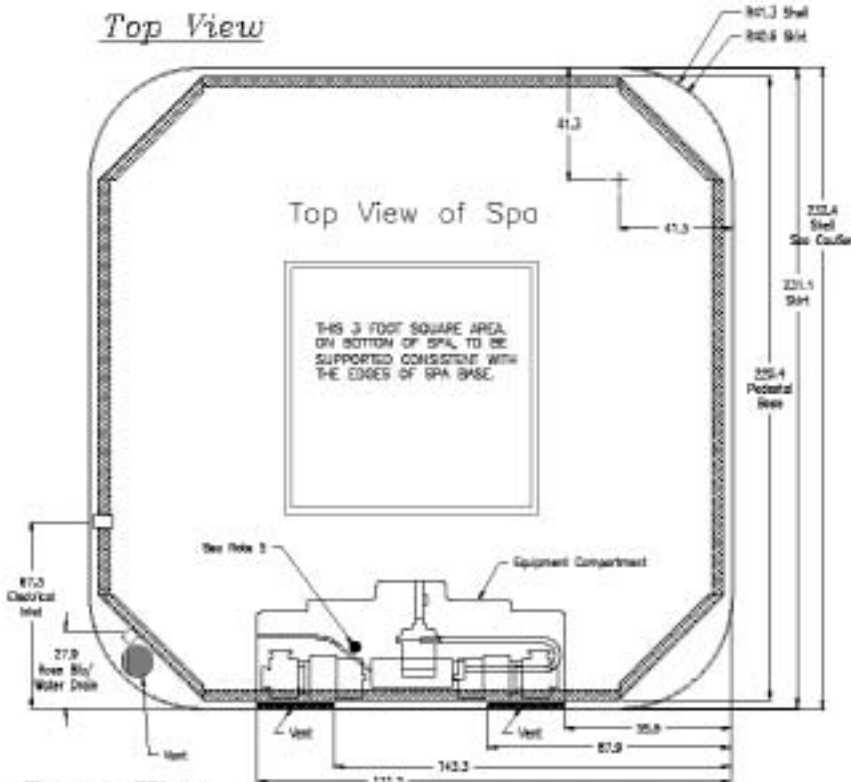

Spa Specifications

Shape	Square
Shell Material	Ultralite/Granite
Depth	234
Width	234
Height	81
Corner Radii	41
Gallons	1514
Capacity	6
Dry Weight	338
Full Weight	1823
Pump Brand	AquaFlo
Motor Size	2.0 Hp
# Pumps/Speed	Two/Single
Light	1
Control System	MSPA-MP-CE
	Scrolling Message
Upper Control	Center
Auxiliary Upper Control	Yes
Programmable	Yes
	90-02 FastFlo
Heater	4.0 Kw
Voltage	240
Amperage	16/2X16/32
GFCI Cord	No
Thermostat	Electronic
Skirt	Wood / Synthetic
Poly Floor	Yes
Gate Valves	4
Valve	2
Pump Systems	4
Drains	4+Floor
Skimmer	8" Wier
VCR Jet-Air Adjustable	9
VCR Jet - Rotator	13
Mini Directional in NFJ	4
VCR Mini Directional	6
VCR Mini Rotator	2
Ozone	1
Typhoon Jet	1
Total Jets	36
Filter	2 x 75
Ultra Pure System	Yes
Pillows	3
NeckFlex Jet	2
Dynamic Message Sequence w/ control panel	No

Front View

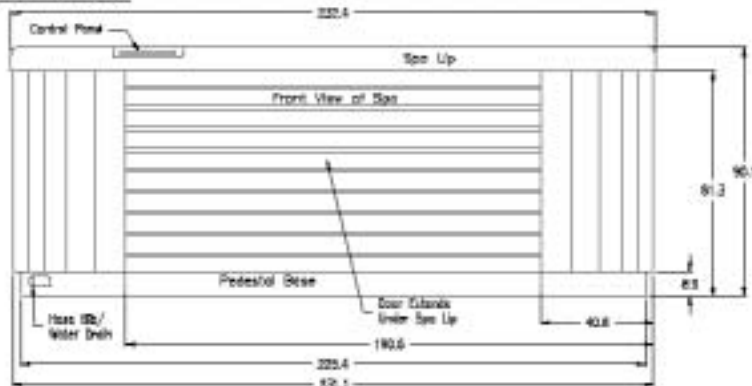

Caution:

Due to manufacturing tolerances there could be some minor differences between the actual measurements of your spa and the drawings above. If site planning is critical to such tolerances, be sure to measure your actual spa.

Note:

1. Subject to change without notice.
2. Engineering specs may differ slightly from brochure.
3. For E-2 Lifter installation allow 18" clearance on the back side of the spa.
4. Alternative cabinets may add significant weight. Ask your dealer for exact details.
5. This is the recommended location for drilling a hole for bringing the power lines in through the bottom of the spa. Be careful not to puncture a plumbing line inside the Equipment Compartment (drill from the inside Compartment out).

Design Checked Drawn/Revised Date J. C. ... R. ... 7/17/02 ECR-2117	Dimension One Specs 2002 D1 (Export) Specs. Dec-149 7/17/02 Page 8 of 11
---------------------------------------------------------------------------------------	-----------------------------------------------------------------------------------------------------

Chairman II



DUE TO MANUFACTURING TOLERANCES THERE COULD BE SOME MINOR DIFFERENCES BETWEEN THE ACTUAL MEASUREMENTS OF YOUR SPA AND THE DRAWING BELOW. IF SITE PLANNING IS CRITICAL TO SUCH TOLERANCES, BE SURE TO MEASURE YOUR ACTUAL SPA.

2002 Chairman II Export

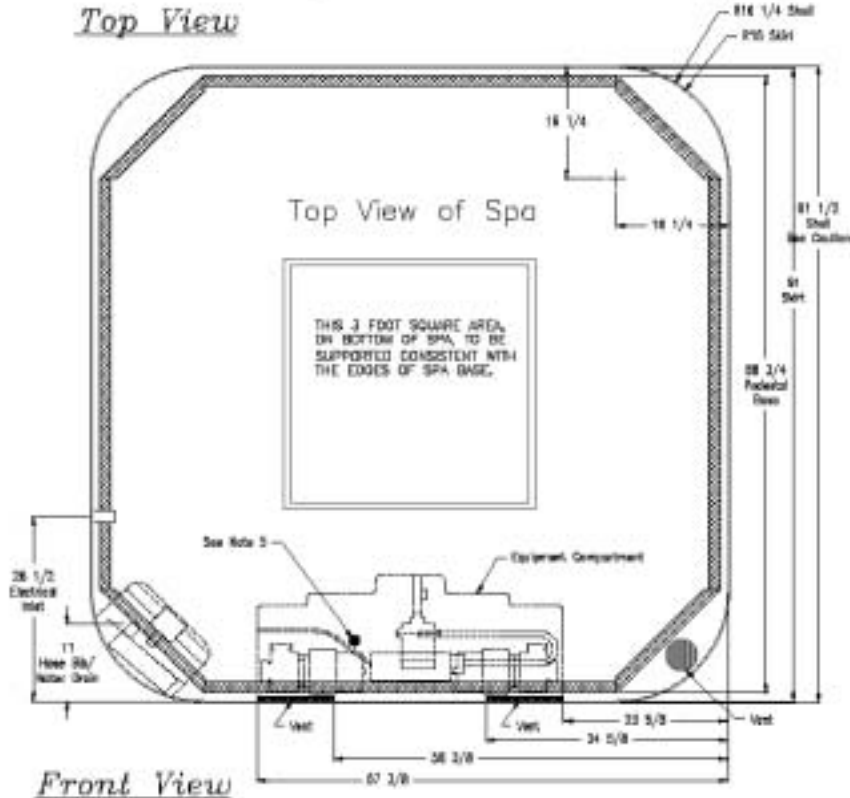

Front View

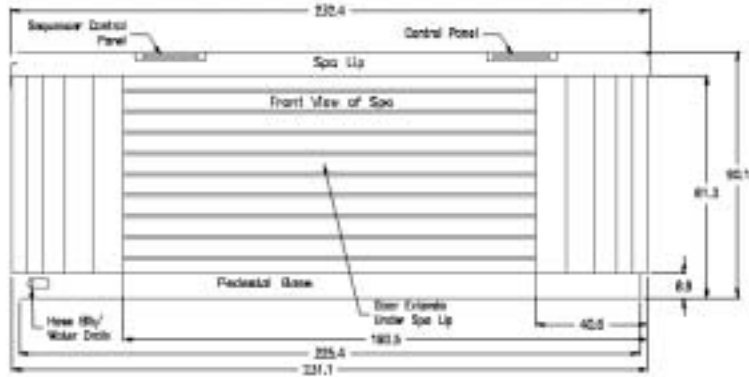

Spa Specifications	
Shape	Square
Shell Material	Ultralite
Depth	204
Width	204
Height	91
Corner Pools	41
Gallons	1514
Capacity	6
Dry Weight	318
Full Weight	1823
Pump Brand	Aqua-fo
Motor Size	2.0 Hp
# Pumps/Speed	Two/Single
Light	1
Control System	MBPAMP/CE
	Scrolling Message
Upper Control	Center
Auxiliary Upper Control	Yes
Programmable	Yes
	99-02 FastFlo
Heater	4.0 Kw
Voltage	240
Amperage	16/20/5/0
GFCI Card	No
Thermostat	Electronic
Skirt	Wood / Synthetic
Poly Floor	Yes
Gate Valves	4
Valve	2
Plumb Systems	4
Drains	4+Floor
Skimmer	8" Weir
VCR Jet Air Adjustable	8
VCR Jet - Rotator	12
Mini Directional in NFJ	6
VCR Mini Directional	6
VCR Mini Rotator	10
Cleaner	1
Typhoon Jet	1
Total Jets	44
Filter	2 x 75
Ultra Pure System	Yes
Pillows	3
NeckFlex Jet	3
Dynamic Message Sequencer w/ control panel	Yes

Caution:

Due to manufacturing tolerances there could be some minor differences between the actual measurements of your spa and the drawings above. If site planning is critical to such tolerances, be sure to measure your actual spa.

Note:

1. Subject to change without notice.
2. Engineering specs may differ slightly from brochure.
3. For E-Z Lifter installation allow 18" clearance on the back side of the spa.
4. Alternative cabinets may add significant weight. Ask your dealer for exact details.
5. This is the recommended location for drilling a hole for bringing the power lines in through the bottom of the spa. Be careful not to puncture a plumbing line inside the Equipment Compartment (drill from the inside Compartment out)

Dealer Name: J. Castillo Dealer Address: 3140 S. Highway 100 City: Phoenix State: AZ Zip: 85032 Phone: 602-2117 Fax: 602-2117	Dimension One Spas 2002 D1 (Export) Spas. Doc-142 7/17/02
-------------------------------------------------------------------------------------------------------------------------------------------------	-------------------------------------------------------------------------------

Diplomat



DUE TO MANUFACTURING TOLERANCES THERE COULD BE SOME MINOR DIFFERENCES BETWEEN THE ACTUAL MEASUREMENTS OF YOUR SPA AND THE DRAWING BELOW. IF SITE PLANNING IS CRITICAL TO SUCH TOLERANCES, BE SURE TO MEASURE YOUR ACTUAL SPA.

2002 Diplomat Export

Top View

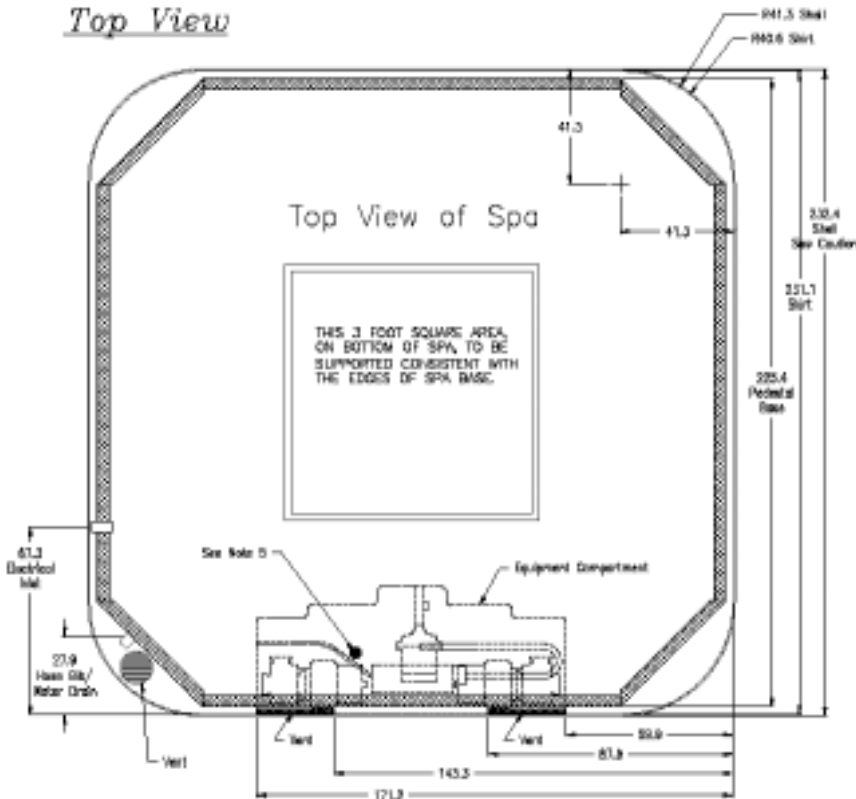

Front View

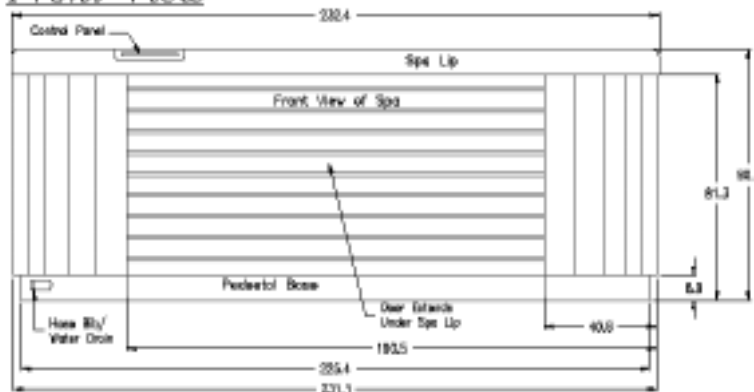

Caution:

Due to manufacturing tolerances there could be some minor differences between the actual measurements of your spa and the drawings above. If site planning is critical to such tolerances, be sure to measure your actual spa.

Note:

1. Subject to change without notice.
2. Engineering specs may differ slightly from brochure.
3. For E-Z Lifter installation allow 18" clearance on the back side of the spa.
4. Alternative cabinets may add significant weight. Ask your dealer for exact details.
5. This is the recommended location for drilling a hole for bringing the power lines in through the bottom of the spa. Be careful not to puncture a plumbing line inside the Equipment Compartment (drill from the inside Compartment out.)

Spa Specifications

Shape	Square
Shell Material	Ultraflex/Granitex
Depth	234
Width	234
Height	91
Corner Radii	41
Gallage	1200
Capacity	5
Dry Weight	331
Full Weight	1696
Pump Brand	Aqua-lo
Motor Size	2.0 Hp
# Pumps/Speed	Two/Single
Light	1
Control System	MSPA-MF-CE
	Scrolling Message Center
Upper Control	
Auxiliary Upper Control	Yes
Programmable	Yes
	99-02 FastFlo
Heater	4.0 kW
Voltage	240
Amperage	16/20/6/32
GFCI Card	No
Thermostat	Electronic
Skirt	Wood / Synthetic
Poly Floor	Yes
Gate Valves	4
Valve	2
Plumb Systems	4
Drains	4+Floor
Skimmer	8" Viscr
VCR Jet-Air Adjustable	8
VCR Jet - Rotator	12
Mini Directional in NFJ	4
VCR Mini Directional	10
VCR Mini Rotator	4
Ozone	1
Typhoon Jet	1
Total Jets	40
Filter	2 x 75
Ultra Pure System	Yes
Pillows	3
NeckFlex Jet	2
Dynamic Massage Sequencer w/ control panel	No

Dimension One Spa	
2002 D1 (Export) Specs.	
Doc-142	7/1/99
Page 1 of 1	

Triad



DUE TO MANUFACTURING TOLERANCES THERE COULD BE SOME MINOR DIFFERENCES BETWEEN THE ACTUAL MEASUREMENTS OF YOUR SPA AND THE DRAWING BELOW. IF SITE PLANNING IS CRITICAL TO SUCH TOLERANCES, BE SURE TO MEASURE YOUR ACTUAL SPA.

2002 Triad Export

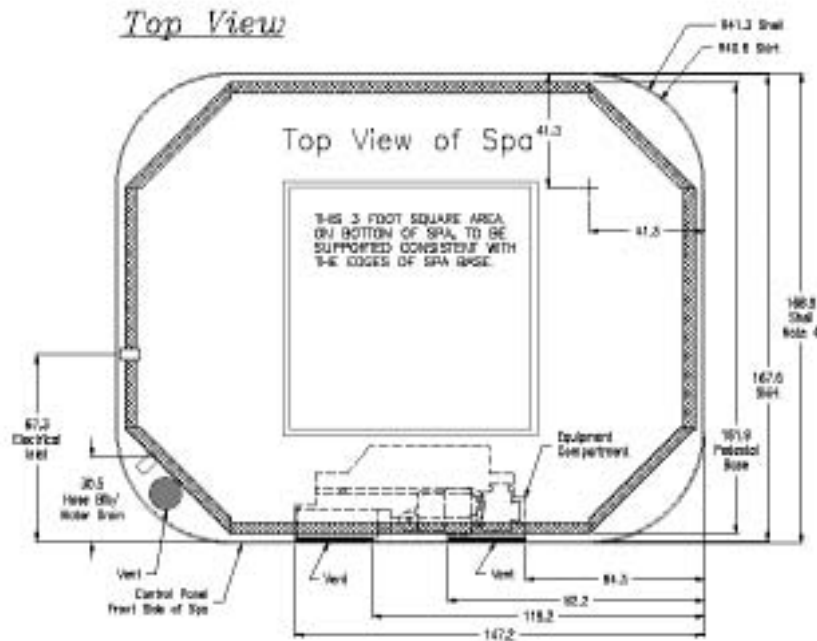

Front View

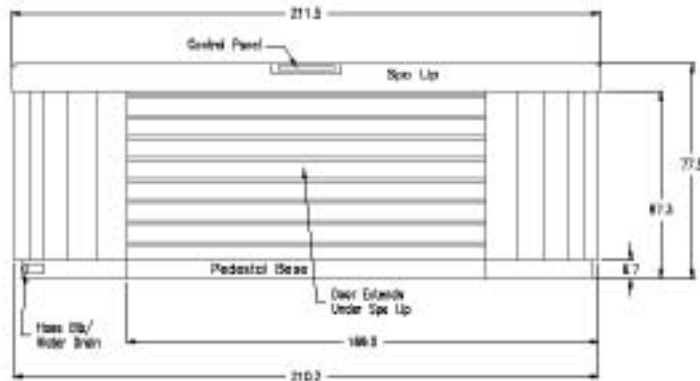

Spa Specifications

Shape	Rectangular
Shell Material	UltraFlo/Granite
Depth	158
Width	214
Height	76
Corner Radii	41
Clutterage	758
Capacity	3+
Dry Weight	175
Full Weight	930
Pump Brand	Aqua-Flo
Motor Size	2.0 Hp
# Pumps/Speed	One/Single
Light	1
Control System	MSPA-MP-CE
Upper Control	Mid Range Control
Auxiliary Upper Control	No
Programmable	Yes
Header	99-02 FastFlo
Voltage	4.0 kW
Amperage	240
GFCI Cord	16/20/5/32
Thermostat	No
Skirt	Electronic
Poly Floor	Wood / Synthetic
Gate Valves	Yes
Valve	2
Plumb Systems	1
Drains	2+Floor
Skimmer	8" Weir
VCR Jet-Air Adjustable	3
VCR Jet - Rotator	4
Mini Directional in NFJ	0
VCR Mini Directional	9
VCR Mini Rotator	2
Ozone	1
Typhoon Jet	0
Total Jets	19
Filter	1 XYS
Ultra Pure System	CMWS Standard
Pillows	3
NeckFlex Jet	0
Dynamic Massage Sequencer w/ control panel	No

Caution:

Due to manufacturing tolerances there could be some minor differences between the actual measurements of your spa and the drawings above. If site planning is critical to such tolerances, be sure to measure your actual spa.

Note:

1. Subject to change without notice.
2. Engineering specs may differ slightly from brochure.
3. For E-2 Litter installation allow 18" clearance on the back side of the spa.
4. Alternative cabinets may add significant weight. Ask your dealer for exact details.

Author	J. Cozette	Dimension One Spa
Rev. Engineer	B. H. Hays	2002 01 (Export) Spec.
Rev. Designer	W. J. Hays	
Rev. Checker	ECR-2117	Dec-14-02
Rev. Approver		1/1/02
Rev. Date		None
Rev. Count		1 of 1

Triad II



DUE TO MANUFACTURING TOLERANCES THERE COULD BE SOME MINOR DIFFERENCES BETWEEN THE ACTUAL MEASUREMENTS OF YOUR SPA AND THE DRAWING BELOW. IF SITE PLANNING IS CRITICAL TO SUCH TOLERANCES, BE SURE TO MEASURE YOUR ACTUAL SPA.

2002 Triad II Export

Top View

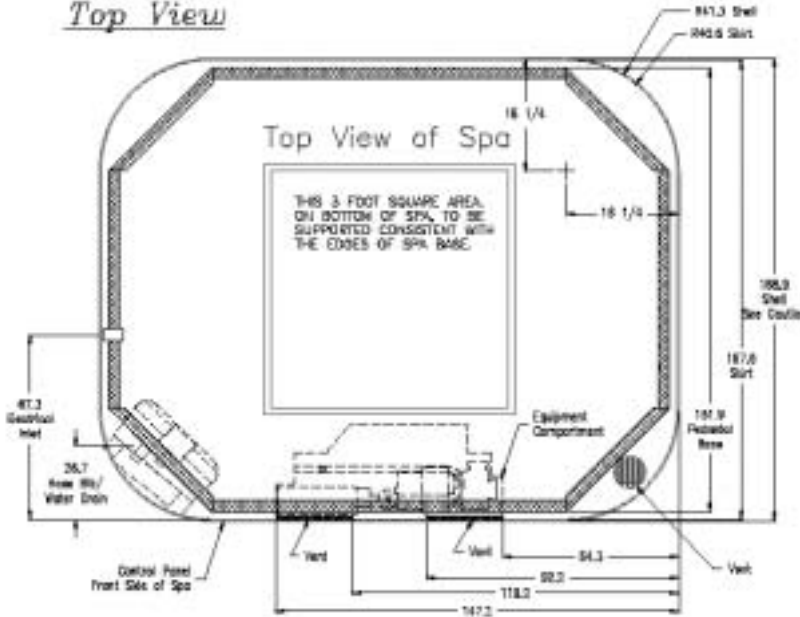

Front View

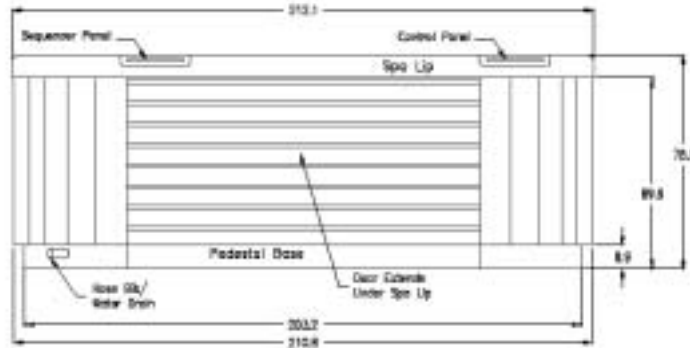

Spa Specifications

Shape	Rectangular
Shell Material	Ultralite/Oronite
Depth	108
Width	214
Height	79
Corner Radii	41
Gateways	198
Capacity	3+
Dry Weight	164
Full Weight	607
Pump Brand	Acqua-Ro
Motor Size	2.2 Hp
# Pump/Speed	One/Single
Light	1
Control System	MSPA-MP-CE
Upper Control	Smoking Message
Auxiliary Upper Control	Center
Programmable	No
Heater	99-02 FastFlo 4.0 kW
Voltage	240
Amperage	18/24/30/32
GFCI Cord	No
Thermostat	Electronic
Shell	Wood / Synthetic
Poly Floor	Yes
Gate Valves	2
Valve	0
Flume Systems	1
Drains	2+Floor
Skimmer	8\"/>
VCR Jet-Air Adjustable	4
VCR Jet - Rotator	7
Mix (Directional or NFJ)	2
VCR Mix Directional	0
VCR Mix Rotator	2
Crown	1
Typhoon Jet	0
Total jets	22
Filter	2 x 15
Ultra Pure System	Yes
Filters	2
HotFix Jet	1
Dynamic Massage Sequencer w/ control panel	Yes

Caution:

Due to manufacturing tolerances there could be some minor differences between the actual measurements of your spa and the drawings above. If site planning is critical to such tolerances, be sure to measure your actual spa.

Note:

1. Subject to change without notice.
2. Engineering specs may differ slightly from brochure.
3. For E-Z Lifter installation allow 18" clearance on the back side of the spa.
4. Alternative cabinets may add significant weight. Ask your dealer for exact details.

Order Number	2002 D1	Order By	J. Caudio	Dimension One Spas	
Model/Description	2002 D1	Site/Project	St. Joseph's		
Order Date	07/17/02	Order No.	ECR-0117	2002 D1 (Export) Spas	
		Order Date	Dec-14-02	Order No.	717702
			None		1 of 1

Cove



DUE TO MANUFACTURING TOLERANCES THERE COULD BE SOME MINOR DIFFERENCES BETWEEN THE ACTUAL MEASUREMENTS OF YOUR SPA AND THE DRAWING BELOW. IF SITE PLANNING IS CRITICAL TO SUCH TOLERANCES, BE SURE TO MEASURE YOUR ACTUAL SPA.

2002 Cove Export

Top View

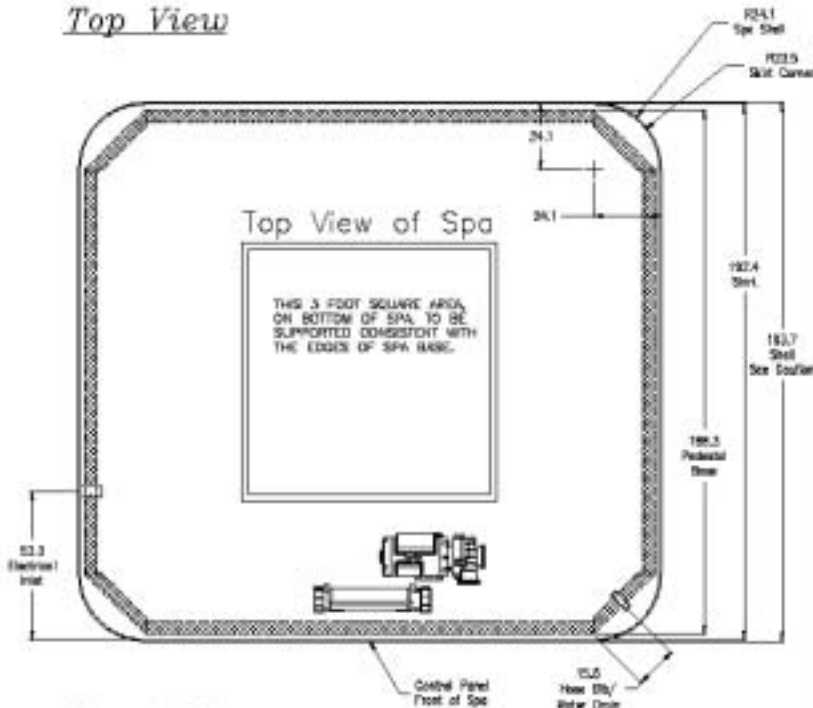

Spa Specifications

Shape	Rectangular
Depth(cm)	172
Width(cm)	213
Height(cm)	76
Corner Radius(cm)	22
Water Capacity (Liters)	1060
Capacity	5
Dry Weight (kg)	213
Full Weight (kg)	1271
Pump Brand	Aqua-fo
Motor Size	2.0 HP
# Pumps/Speed	One/Dual
Light	1 w/ optional Dynamic Lighting
Control System	Gecko SSPA-D 13-CE
Upper Control Programmable	Oval 101-02 Programmable Digital
Heater	Yes
Voltage	2.0 KW
Amperage	240
GFCI Cord	16/2X16/32
Thermostat	No
Skirt Panel	Electronic
Poly Floor	Wood or Synthetic
Gate Valves	Yes
Valve	0
Plumb Systems	1
Drains	2
Skimmer	1
VCR Jet - Air Adjustable	20cm Weir
VCR Jet - Rotator	1
VCR Mini Directional	4
VCR Mini Rotator	2
Ozone	0
Non-Adjustable	1
Euro Jet	14
Typhoon Jet	0
Total Jets	22
Filter	75
Ozone Ready	Yes
5\"/>	

Front View

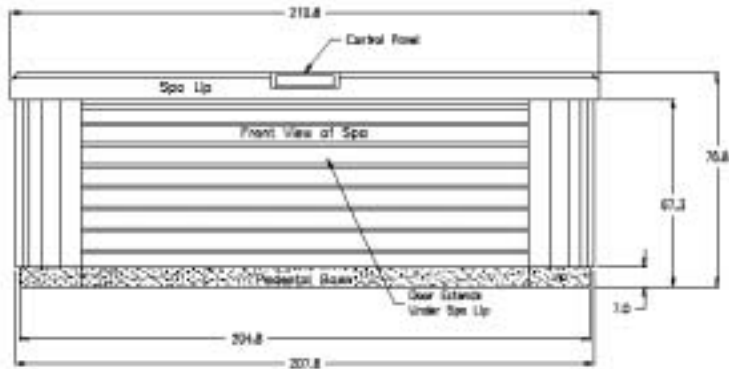

Caution:

Due to manufacturing tolerances there could be some minor differences between the actual measurements of your spa and the drawings above. If site planning is critical to such tolerances, be sure to measure your actual spa.

Note:

1. Subject to change without notice.
2. Engineering specs may differ slightly from brochure.
3. For E-Z Lifter installation allow 18" clearance on the back side of the spa.
4. Alternative cabinets may add significant weight. Ask your dealer for exact details.

Order Number	Order Date	Order Status	Order Total
2002 @ Home Spa(Export)	07/17/02	None	0
ECR 2117	07/17/02	None	0
None	0	None	0

Cove HP



DUE TO MANUFACTURING TOLERANCES THERE COULD BE SOME MINOR DIFFERENCES BETWEEN THE ACTUAL MEASUREMENTS OF YOUR SPA AND THE DRAWING BELOW. IF SITE PLANNING IS CRITICAL TO SUCH TOLERANCES, BE SURE TO MEASURE YOUR ACTUAL SPA.

2002 Cove HP Export

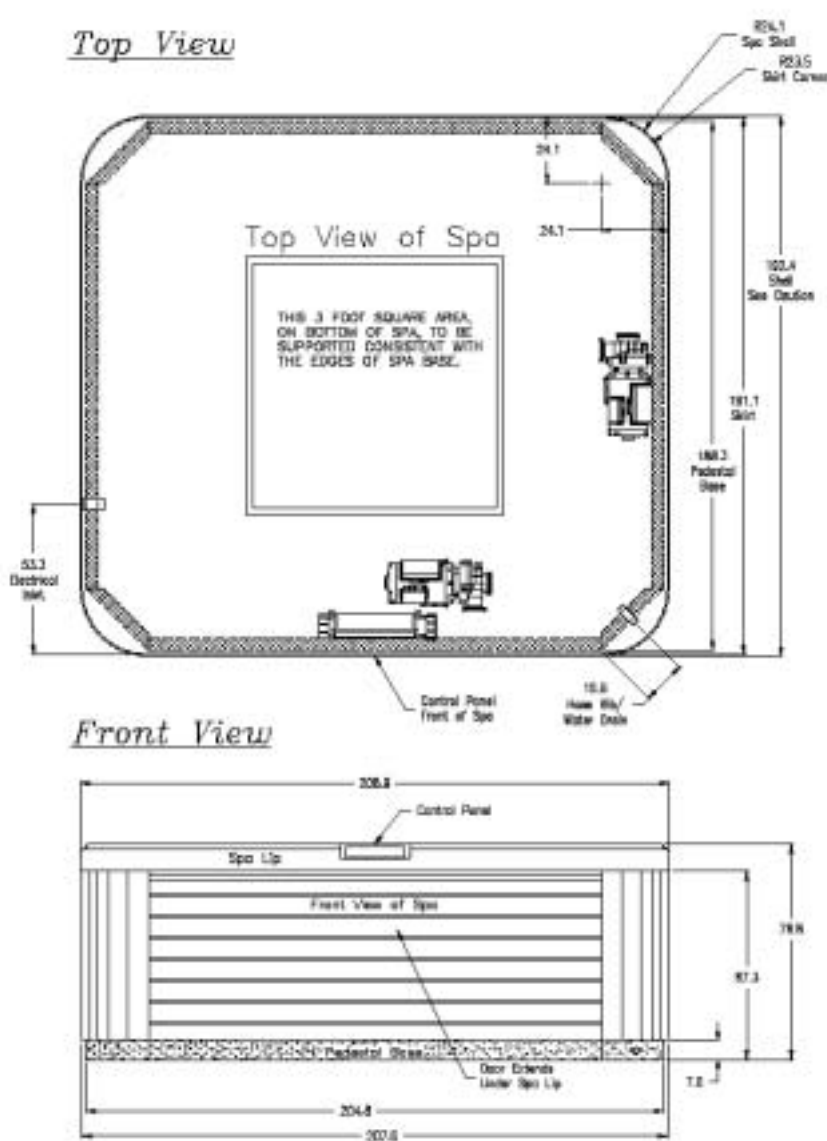

Spa Specifications	
Shape	Rectangular
Depth (cm)	198
Width (cm)	213
Height (cm)	76
Corner Radii (cm)	22
Water Capacity (Liters)	1059
Capacity	5
Dry Weight (kg)	231
Full Weight (kg)	1287
Pump Brand	Aqua-fo
Motor Size	2.0 HP
# Pumps/Speed	One Dual & One Single
Light	1 w/ optional Dynamic Lighting
Control System	Geko SSPA-D13-CE
Upper Control	Oval '01-'02 Programmable
Programmable	Digital
Heater	2.0 KW
Voltage	240
Amperage	16/2X16/32
GFCI Cord	No
Thermostat	Electronic
Skirt Panel	Wood or Synthetic
Poly Floor	Yes
Gate Valves	0
Valve	0
Pump Systems	2
Drains	4
Skimmer	20cm Weir
VCR Jet - Air Adjustable	1
VCR Jet - Rotator	4
VCR Mini Directional	5
VCR Mini Rotator	0
Opera	1
Non-Adjustable Euro Jet	27
Typhoon Jet	0
Total Jets	38
Filter	75
Come Ready Lid	Yes
8" Urethane Filter Lid	Yes
Pilows Flush Mount	3

Caution:

Due to manufacturing tolerances there could be some minor differences between the actual measurements of your spa and the drawings above. If site planning is critical to such tolerances, be sure to measure your actual spa.

Note:

1. Subject to change without notice.
2. Engineering spaces may differ slightly from brochures.
3. For E-Z Lifter installation allow 18" clearance on the back side of the spa.
4. Alternative cabinets may add significant weight. Ask your dealer for exact details.

Dimension One Spas	
Prepared By: J. Castillo	Doc No: 2002 @Home Spas(Export)
Checked By: B. Hastings	Doc No: 144
Date: 7/17/02	Rev: 8
ECR 2117	7/17/02
Doc No: 144	Rev: 8
Page: 1	Total: 1 of 1

Dream



DUE TO MANUFACTURING TOLERANCES THERE COULD BE SOME MINOR DIFFERENCES BETWEEN THE ACTUAL MEASUREMENTS OF YOUR SPA AND THE DRAWING BELOW. IF SITE PLANNING IS CRITICAL TO SUCH TOLERANCES, BE SURE TO MEASURE YOUR ACTUAL SPA.

2002 Dream Export

Top View

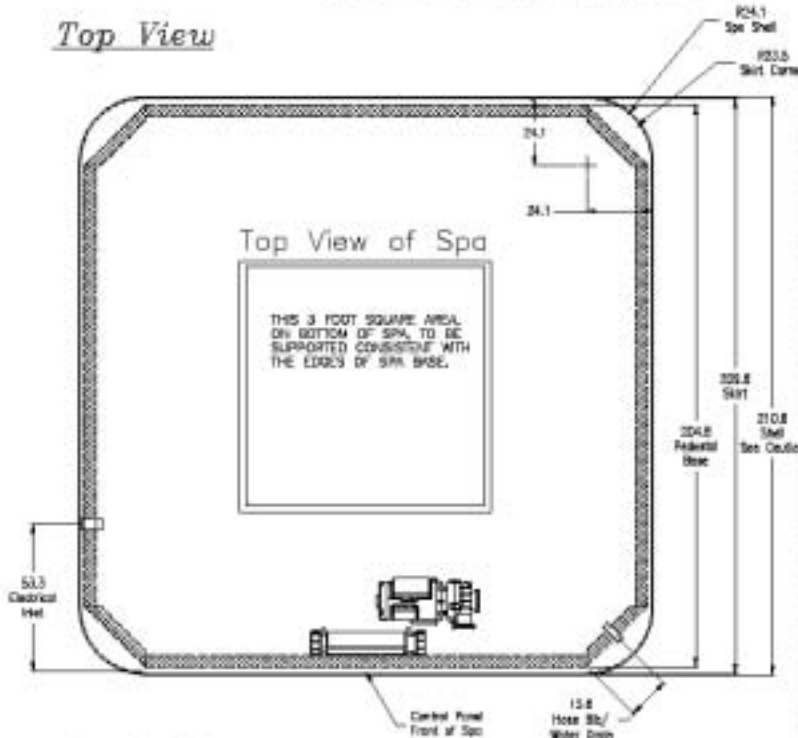

Spa Specifications

Shape	Square
Depth (cm)	213
Width (cm)	213
Height (cm)	91
Corner Radii (cm)	22
Water Capacity (Liters)	117.3
Capacity	8
Dry Weight (kg)	225
Full Weight (kg)	1393
Pump Brand	Aqua-fo
Motor Size	2.0 HP
# Pumps/Speed	One/Dual
Light	1 w/ optional Dynamic Lighting
Control System	Gecko SSPA-D13-CE
Upper Control	Oval '01-'02 Programmable Digital
Programmable	Yes
Heater	2.0 KW
Voltage	240
Ampereage	16/2X16/32
GFCI Cord	No
Thermostat	Electronic
Skirt Panel	Wood or Synthetic
Poly Floor	Yes
Gate Valves	0
Valve	0
Plumb Systems	1
Drains	2
Skimmer	20 cm Weir
VCR Jet - Air Adjustable	1
VCR Jet - Rotorator	4
VCR Mini Directional	2
VCR Mini Rotorator	0
Ozone	1
Non-Adjustable Euro Jet	14
Typhoon Jet	0
Total Jets	22
Filter	75
Ozone Ready	Yes
8" Urethane Filter Lid	Yes
Pilows Flush Mount	After Market Available

Front View

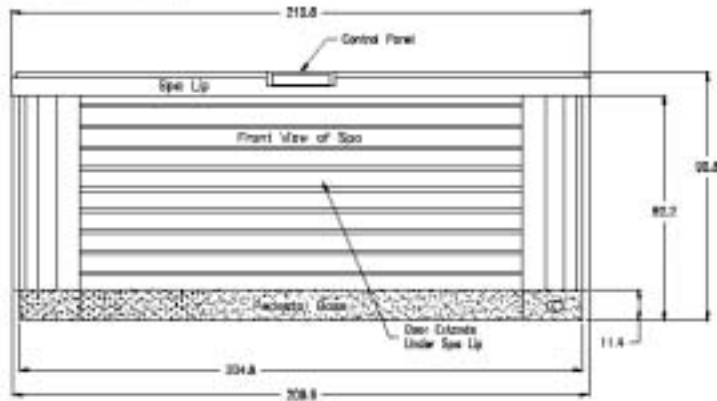

Caution:

Due to manufacturing tolerances there could be some minor differences between the actual measurements of your spa and the drawings above. If site planning is critical to such tolerances, be sure to measure your actual spa.

Note:

1. Subject to change without notice.
2. Engineering specs may differ slightly from brochure.
3. For C-2 Lifter installation allow 18" clearance on the back side of the spa.
4. Alternative cabinets may add significant weight. Ask your dealer for exact details.

Order Number	211782	Order Date	7/17/02
Customer Name	J. Caudio	Order Ref	2002 @Home Spa(Export)
Order Address	111782	Order Ref	2002 @Home Spa(Export)
Order City	ECR 2117	Order Ref	2002 @Home Spa(Export)
Order State	None	Order Ref	2002 @Home Spa(Export)
Order Zip	None	Order Ref	2002 @Home Spa(Export)
Order Total	None	Order Ref	2002 @Home Spa(Export)
Order Tax	None	Order Ref	2002 @Home Spa(Export)
Order Ship	None	Order Ref	2002 @Home Spa(Export)
Order Ins	None	Order Ref	2002 @Home Spa(Export)
Order Total	None	Order Ref	2002 @Home Spa(Export)

Dream HP



DUE TO MANUFACTURING TOLERANCES THERE COULD BE SOME MINOR DIFFERENCES BETWEEN THE ACTUAL MEASUREMENTS OF YOUR SPA AND THE DRAWING BELOW. IF SITE PLANNING IS CRITICAL TO SUCH TOLERANCES, BE SURE TO MEASURE YOUR ACTUAL SPA.

2002 Dream HP Export

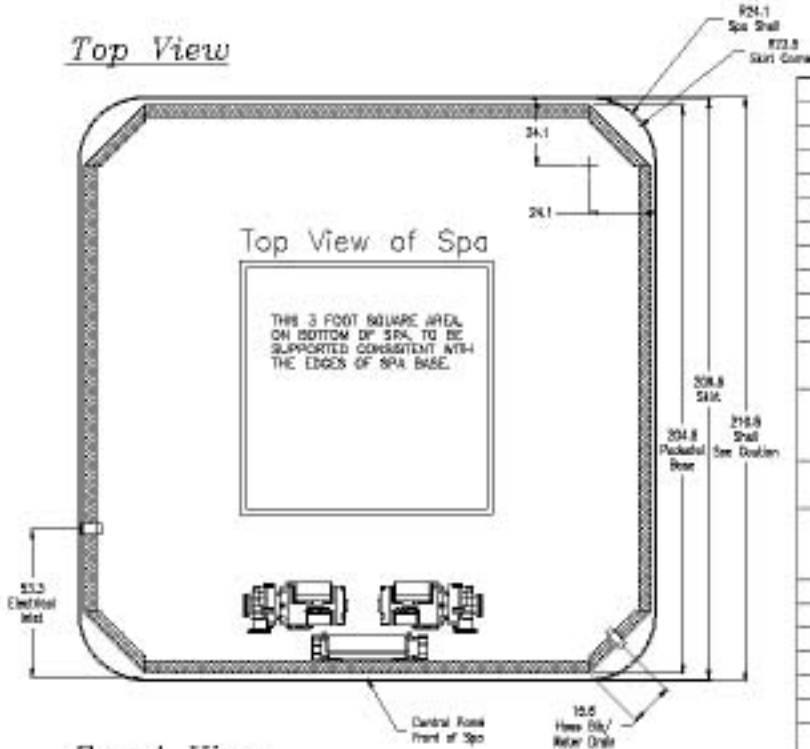

Spa Specifications	
Shape	Square
Depth	213
Width (cm)	213
Height (cm)	91
Corner Radii (cm)	23
Water Capacity (Liters)	1173
Capacity	6
Dry Weight (kg)	265
Full Weight (kg)	1434
Pump Brand	Aqua-fo
Motor Size	2.0HP
#Pumps/Speed	One/Dual & One Single
Light	1 w/ optional Dynamic Lighting
Control System	GeoCo SSPA-D13-CE
Upper Control	Dual '01-'02 Programmable Digital
Programmable	Yes
Heater	2.0 KW
Voltage	240
Amperage	18/2X18/32
GFCI Cord	No
Thermostat	Electronic
Skirt Panel	Wood or Synthetic
PolyFloor	Yes
Gate Valves	0
Valve	0
Plumb Systems	2
Drains	4
Skimmer	20 cm Weir
VCR Jet - Air Adjustable	1
VCR Jet - Rotator	4
VCR Mini Directional	9
VCR Mini Rotator	0
Cone	1
Non-Adjustable Euro Jet	25
Typhoon Jet	0
Total Jets	41
Filter	75
Core Ready	Yes
8" Urethane Filter Lid	Yes
Pilows Flush Mount	3

Front View

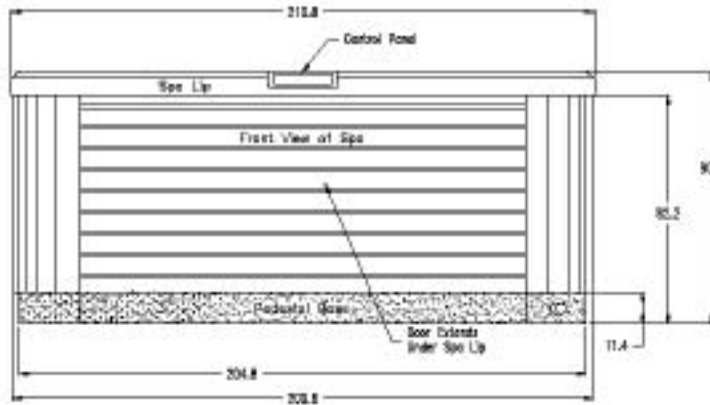

Caution:

Due to manufacturing tolerances there could be some minor differences between the actual measurements of your spa and the drawings above. If site planning is critical to such tolerances, be sure to measure your actual spa.

Note:

1. Subject to change without notice.
2. Engineering specs may differ slightly from brochure.
3. For E-2 Lifter installation allow 18" clearance on the back side of the spa.
4. Alternative cabinets may add significant weight. Ask your dealer for exact details.

Revision History		Dimension One Spa	
Revision Number	Revision Description	Revision Number	Revision Description
1	J. Gaudin	1	2002 @Home Spec(Export)
2	S. Hastings	2	Doc-144
3	1/10/02	3	1/1/02
4	ECR 2517	4	1/1/02

Sojourn HP



DUE TO MANUFACTURING TOLERANCES THERE COULD BE SOME MINOR DIFFERENCES BETWEEN THE ACTUAL MEASUREMENTS OF YOUR SPA AND THE DRAWING BELOW. IF SITE PLANNING IS CRITICAL TO SUCH TOLERANCES, BE SURE TO MEASURE YOUR ACTUAL SPA.

2002 Sojourn HP Export

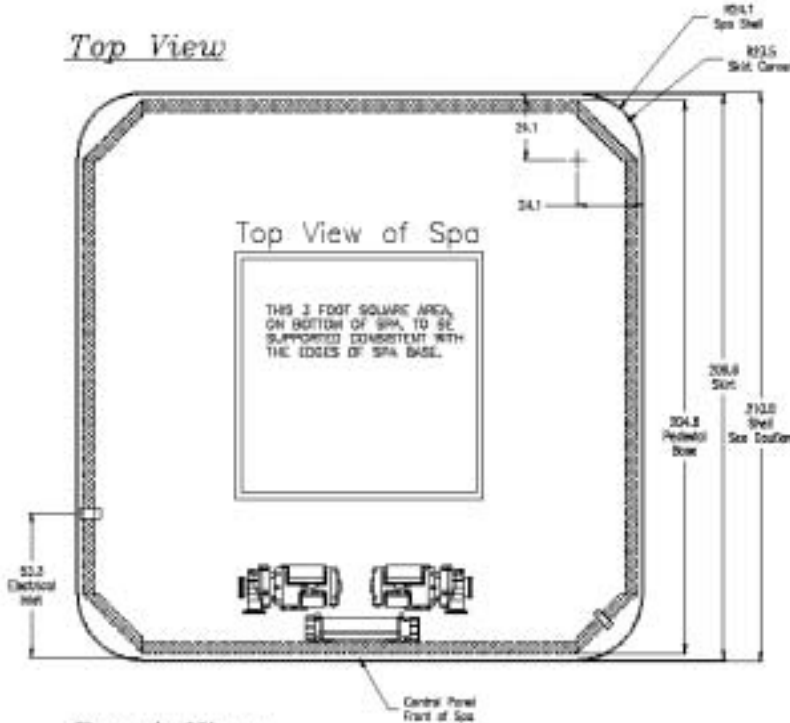

Spa Specifications	
Shape	Square
Depth(cm)	213
Width(cm)	213
Height(cm)	91
Corner Radius(cm)	22
Water Capacity (Liters)	1287
Capacity	7
Dry Weight (kg)	272
Full Weight (kg)	1555
Pump Brand	Aqua-Ro
Motor Size	2.0 HP
# Pumps/Speed	One/Dual & One/Single
Light	1 w/ optional Dynamic Lighting
Control System	Gecko 5SPA-D13-CE Oval '01-'02 Programmable Digital
Upper Control Programmable	Yes
Heater	2.0 KW
Voltage	240
Amperage	16.2 X 16.02
GFCI Cord	No
Thermostat	Electronic
Skirt Panel	Wood or Synthetic
Poly Floor	Yes
Gate Valves	0
Valve	0
Plumb Systems	2
Drains	4
Skimmer	20cm Weir
VCR Jet - Air Adjustable	1
VCR Jet - Rotator	4
VCR Mini Directional	16
VCR Mini Rotator	0
Ozone	1
Non-Adjustable Euro Jet	26
Typhoon Jet	0
Total Jets	42
Filter	75
Ozone Ready	Yes
8" Urethane Filter Lid	Yes

Front View

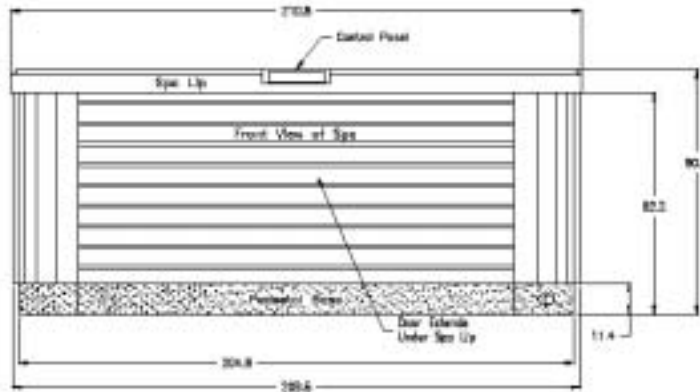

Caution:

Due to manufacturing tolerances there could be some minor differences between the actual measurements of your spa and the drawings above. If site planning is critical to such tolerances, be sure to measure your actual spa.

Note:

1. Subject to change without notice.
2. Engineering specs may differ slightly from brochure.
3. For E-2 Lifter installation allow 18" clearance on the back side of the spa.
4. Alternative cabinets may add significant weight. Ask your dealer for exact details.

Dimension One Spas	
Model Number	2002 @Home Spa(Export)
Order Number	Doc-144
Part Number	71762
File	7/17/02
Page	1 of 1

@ Home Hot Tubs

GECKO SSPA ELECTRICAL HOOK-UP
DIAGRAM FOR 120 VAC, 60 HZ
APPLICATIONS (COVE & COMPANION);

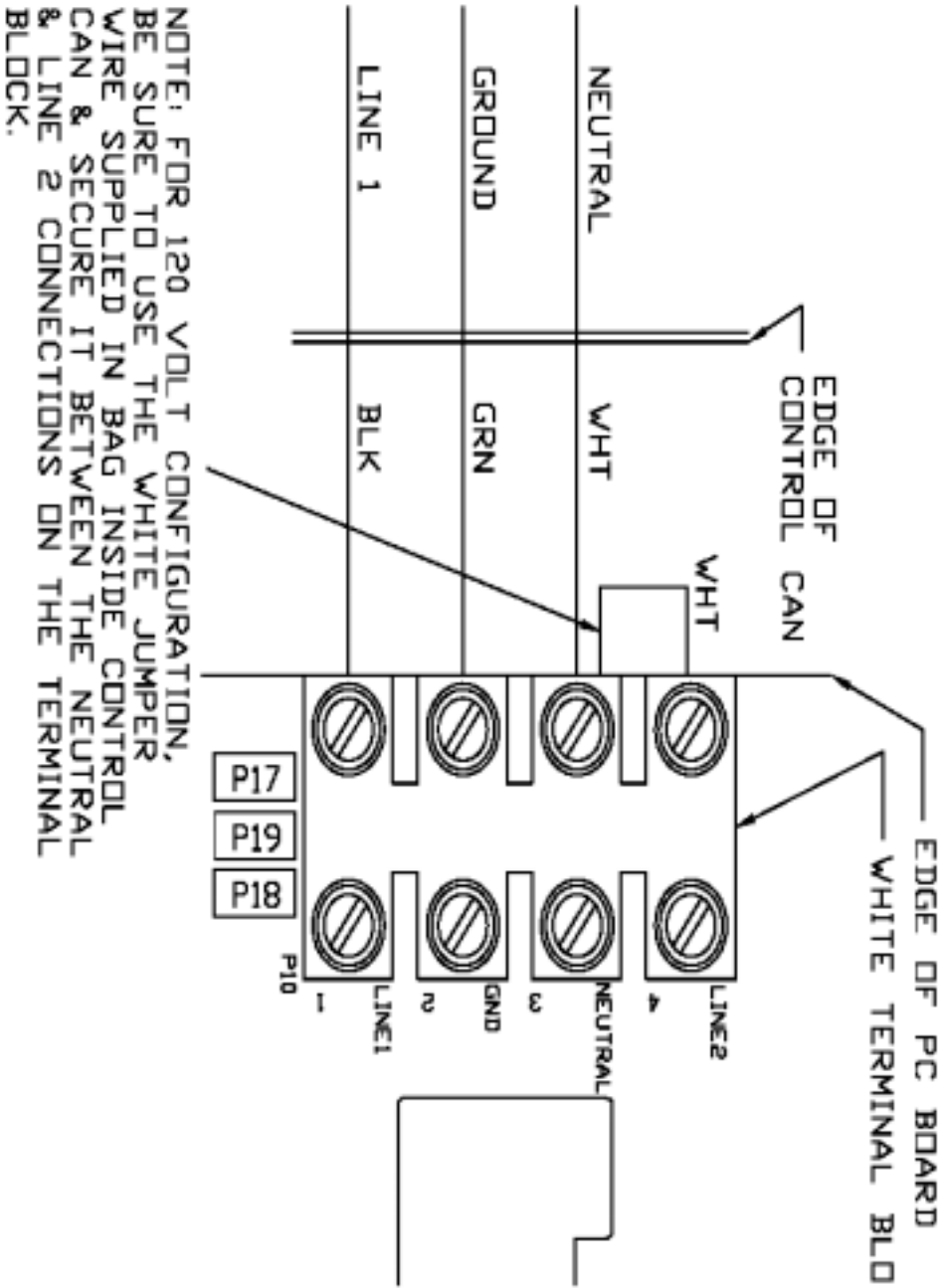

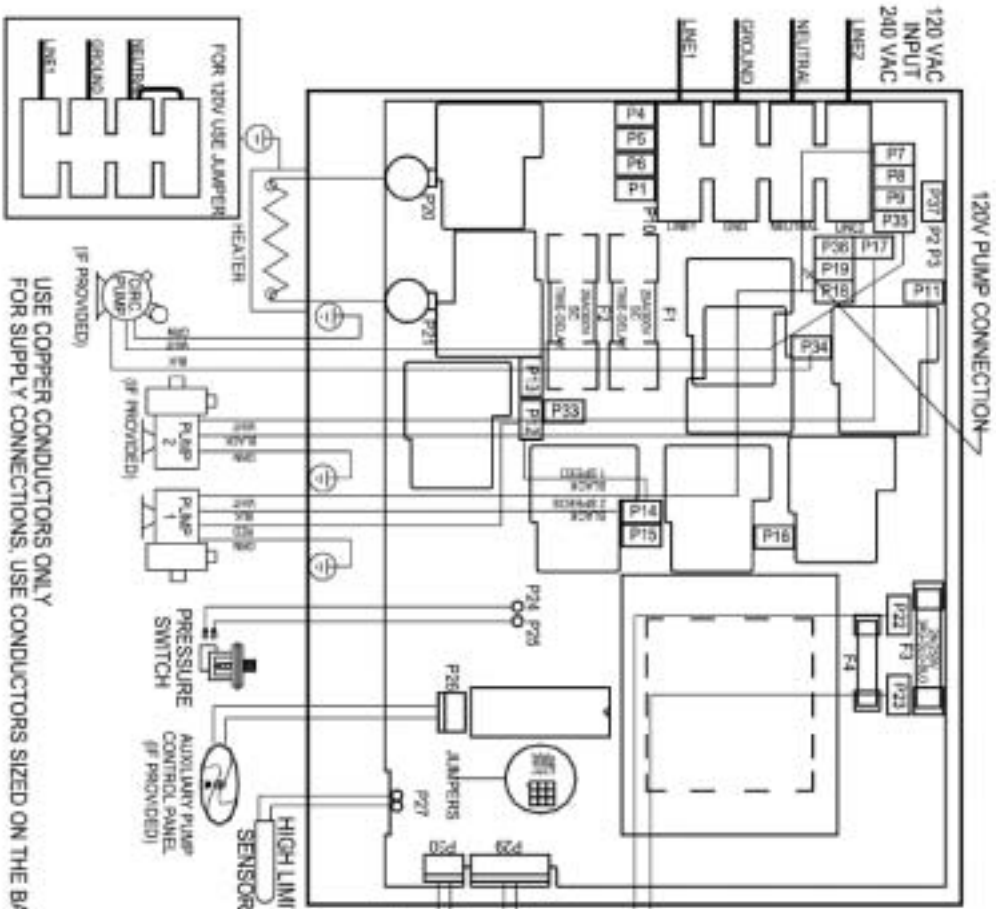

FOR 120V USE JAMPER

USE COPPER CONDUCTORS ONLY
FOR SUPPLY CONNECTIONS, USE CONDUCTORS SIZED ON THE BASIS OF 60°C AMPACITY BUT RATED MINIMUM 90°C

1-800-78-0ECHO
INTL. 800-435-4000

SPASAP P102 P113 01-02-13 H43 JAM 013
5204-01C

JAMPER SETTINGS

JMP1 - NO OZONE - 10 OZONE

JMP2 - NO CIRC. PUMP - CIRC. PUMP

JMP3 - SINGLE PUMP - DUAL PUMP

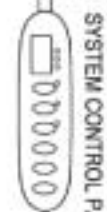

PUMP #1 CONNECTOR (2 SPEEDS)

VOLTAGE	120V	240V
GREEN (OZONE)	P14	P16
BLACK (120V SPEED)	P15	P17
RED (240V SPEED)	P18	P19
WHITE (NEUTRAL)	P19	P20

PUMP #2 CONNECTOR

VOLTAGE	120V	240V
GREEN (OZONE)	P20	P22
BLACK (120V)	P21	P23
WHITE (NEUTRAL)	P23	P24

HEATER 240V

VOLTAGE	120V	240V
GREEN (OZONE)	P20	P22
BLACK (120V)	P21	P23
WHITE (NEUTRAL)	P23	P24

PRESSURE SWITCH

VOLTAGE	120V	240V
GREEN (OZONE)	P18	P20
BLACK (120V)	P19	P21
WHITE (NEUTRAL)	P21	P22

HEATER 240V

VOLTAGE	120V	240V
GREEN (OZONE)	P20	P22
BLACK (120V)	P21	P23
WHITE (NEUTRAL)	P23	P24

TEMPERATURE SENSOR

VOLTAGE	120V	240V
GREEN (OZONE)	P26	P28
BLACK (120V)	P27	P29
WHITE (NEUTRAL)	P29	P30

HEATER 240V

VOLTAGE	120V	240V
GREEN (OZONE)	P20	P22
BLACK (120V)	P21	P23
WHITE (NEUTRAL)	P23	P24

HEATER 240V

VOLTAGE	120V	240V
GREEN (OZONE)	P20	P22
BLACK (120V)	P21	P23
WHITE (NEUTRAL)	P23	P24

Spa Information

It is very important that you gather the following information on your spa and enter it in the blanks provided below. The **Warranty Card** should also be completed at the same time, and submitted to the address below. This information will be required if you ever want to purchase additional items for your spa, or if service is ever required. Be sure to consult with your Dealer to ensure the accuracy of this important information.

My Spa

Model Name:	_____	Serial Number:	_____
Date Purchased:	_____	Date Installed:	_____
Notes:	_____ _____ _____ _____ _____		

Dealer Information:

Dimension One Spas Inc. Information



2611 Business Park Drive
Vista, California 92083
800.345.7727
760.727.7727
fax 760.734.4425

www.D1Spas.com
www.AtHomeHotTubs.com



DIMENSION ONE SPAS®

HOME HYDROTHERAPY

2611 Business Park Drive

Vista, California 92083

800.345.7727

760.727.7727

fax 760.734.4425

Part No. 01513-281E Rev B

©2002 Dimension One Spas Inc.